

GE Infrastructure
Sensing



TransPort[®] Model PT878
Panametrics Portable Liquid Flowmeter
User's Manual



GE Infrastructure Sensing

TransPort® Model PT878 *Panametrics Portable Liquid Flowmeter*



User's Manual
910-219C
March 2005

TransPort® is a GE Panametrics product. GE Panametrics has joined other GE high-technology sensing businesses under a new name—GE Infrastructure Sensing.



Warranty

Each instrument manufactured by GE Infrastructure Sensing, Inc. is warranted to be free from defects in material and workmanship. Liability under this warranty is limited to restoring the instrument to normal operation or replacing the instrument, at the sole discretion of GE Infrastructure Sensing, Inc. Fuses and batteries are specifically excluded from any liability. This warranty is effective from the date of delivery to the original purchaser. If GE Infrastructure Sensing, Inc. determines that the equipment was defective, the warranty period is:

- one year from delivery for electronic or mechanical failures
- one year from delivery for sensor shelf life

If GE Infrastructure Sensing, Inc. determines that the equipment was damaged by misuse, improper installation, the use of unauthorized replacement parts, or operating conditions outside the guidelines specified by GE Infrastructure Sensing, Inc. , the repairs are not covered under this warranty.

The warranties set forth herein are exclusive and are in lieu of all other warranties whether statutory, express or implied (including warranties of merchantability and fitness for a particular purpose, and warranties arising from course of dealing or usage or trade).

Return Policy

If a GE Infrastructure Sensing, Inc. instrument malfunctions within the warranty period, the following procedure must be completed:

1. Notify GE Infrastructure Sensing, Inc., giving full details of the problem, and provide the model number and serial number of the instrument. If the nature of the problem indicates the need for factory service, GE Infrastructure Sensing, Inc. will issue a RETURN AUTHORIZATION NUMBER (RAN), and shipping instructions for the return of the instrument to a service center will be provided.
2. If GE Infrastructure Sensing, Inc. instructs you to send your instrument to a service center, it must be shipped prepaid to the authorized repair station indicated in the shipping instructions.
3. Upon receipt, GE Infrastructure Sensing, Inc. will evaluate the instrument to determine the cause of the malfunction.

Then, one of the following courses of action will then be taken:

- If the damage is covered under the terms of the warranty, the instrument will be repaired at no cost to the owner and returned.
- If GE Infrastructure Sensing, Inc. determines that the damage is not covered under the terms of the warranty, or if the warranty has expired, an estimate for the cost of the repairs at standard rates will be provided. Upon receipt of the owner's approval to proceed, the instrument will be repaired and returned.

Table of Contents

Chapter 1: Features and Capabilities

Overview	1-1
System Description	1-3
The Flowcell	1-3
Electronics Package	1-4
Theory of Operation.....	1-5

Chapter 2: Initial Setup

Making Electrical Connections	2-2
Power Connections.....	2-3
Transducer Connections.....	2-3
Input/Output Connections	2-3
The Infrared Wireless Interface	2-4
Charging and/or Replacing Batteries.....	2-5
Charging the Batteries	2-5
Replacing the Batteries.....	2-6
Powering ON and OFF.....	2-7
Using the Screen and Keypad	2-10
Screen.....	2-10
Keypad.....	2-12
Obtaining On-Line Help.....	2-14

Table of Contents (cont.)

Chapter 3: Programming Site Data

Entering the Program Menu	3-2
Entering Transducer Parameters	3-3
Parameters for Special Transducers.....	3-5
Confirming Entries	3-6
Entering Pipe Parameters	3-7
Entering Pipe Lining Parameters	3-11
Entering Fluid Types and Speeds.....	3-13
Entering the Signal Path Parameters.....	3-16
Path Parameters for Clamp-On Transducers.....	3-17
Path Parameters for Wetted Transducers	3-18
Entering the Energy Option Parameters.....	3-19
Entering Inputs in the Energy Option.....	3-21
Entering Custom Cp Data in the Energy Option ...	3-24
Entering Analog Inputs	3-27
Entering General-Purpose Analog Inputs	3-27
Entering Analog Inputs in the Energy Option.....	3-29
Entering the Analog Output.....	3-31
Entering the Digital Output	3-34
Entering User Functions	3-38
Entering Correction Factors	3-42
Entering Reynolds Correction	3-42
Entering a Calibration Factor	3-44

Table of Contents (cont.)

Chapter 4: Creating and Managing Sites

The Site Manager	4-2
Creating a New Site	4-4
Opening an Existing Site	4-6
Saving a Site	4-7
Saving a Site with a Different Name	4-8
Refreshing a Site	4-9
Renaming a Site	4-9
Deleting a Site	4-10
Creating a Site Message	4-11
Printing a Current Site	4-13
Transferring a Site File to a PC	4-13
Transferring a Site File in Text Format to a PC	4-14
Transferring a File from a PC to the PT878	4-15
Listing Files by Name	4-18
Listing Files in Chronological Order	4-18

Chapter 5: Displaying and Configuring Data

The Format Option	5-2
The View Option	5-4
The Limits Option	5-5
The Measurement Option	5-7
Customizing the Display Screen	5-9
Specifying the Number of Displayed Parameters	5-10
Customizing Softkeys	5-11
Managing Files — The Drive Manager	5-14
Transferring a File to a PC	5-16
Transferring a File from a PC to the PT878	5-17
Refreshing a File	5-19
Deleting a File	5-19
Listing Files by Name	5-20
Listing Files in Chronological Order	5-21
Accessing Meter Data — The About Option	5-22

Table of Contents (cont.)

Chapter 6: Programming Meter Settings

Entering the Meter Menu	6-2
Selecting Measurement Units.....	6-3
The Battery Charger	6-4
Entering Date and Time	6-6
Changing Date and Time Appearance	6-8
Adjusting the Contrast	6-11
Setting Backlight Timeout.....	6-13
Changing the Display Language.....	6-14
Changing Communications Parameters.....	6-16
Resetting Forward and Reverse Totals	6-19
Setting Up User Tables	6-20
Taking a Bitmap Capture of a Current Screen	6-24

Table of Contents (cont.)

Chapter 7: Logging Data

Entering the Logging Menu	7-2
The Log Manager	7-3
The File Menu	7-4
Setting up a New Log	7-5
Copying (Cloning) a Selected Log	7-10
Renaming a Log	7-11
Deleting a Log	7-11
Deleting All Logs	7-12
Refreshing the Log Manager Screen	7-12
Printing a Log	7-13
Transferring a Log to a PC	7-14
The Log Menu	7-15
Stopping (Pausing) a Log	7-16
Restarting a Log	7-16
Ending a Log	7-16
Stopping All Logs	7-17
Restarting All Logs	7-17
Ending All Logs	7-17
View All Sites	7-17
The View Menu	7-18
Displaying Log Details	7-19
Displaying Log Data in Graphical Form	7-20
Displaying Log Data in Spreadsheet Form	7-23
The Sort Menu	7-24
Listing Logs by Name	7-24
Listing Logs in Chronological Order	7-24

Table of Contents (cont.)

Chapter 8: Servicing the PT878

Entering the Service Menu.....	8-2
Printing Reports.....	8-3
Setting up the Thickness Gauge.....	8-5
Measuring Pipe Wall Thickness	8-6
Entering the Material and Sound Speed	8-6
Measuring Thickness in Numeric Format	8-8
Displaying the Receive Signal in Graphical Format .	8-9
Calibrating the Thickness Gauge Transducer	8-11
Calculating Velocity (Pipe Material Sound Speed) .	8-14
Programming the Thickness Gauge	8-17
Displaying Diagnostic Parameters	8-20
Calibrating the Analog Output and Inputs	8-21
Calibrating the Analog Output	8-21
Calibrating Inputs	8-23
Setting up Signal Parameters.....	8-25
Setting up Signal Parameters	8-26
Setting up Peak Detection	8-28
Selecting the Transmit Code	8-30
Setting Error Limits.....	8-31
The Test Option	8-34
Testing the Screen	8-35
Testing the Keys	8-36
Testing the Watchdog Timer Circuit	8-37
Setting Impulse Response	8-38
Taking Wave Samples for Diagnosis.....	8-39
Applying a Stored Signal for Diagnosis	8-39
Testing the Battery	8-40
Resetting to Factory Default Parameters.....	8-41
Updating PT878 Software	8-42
Updating Software Via IrOBEX	8-43
Updating Software Via IrCOMM	8-45

Table of Contents (cont.)

Chapter 9: Diagnostics and Troubleshooting

Error Code Messages.....	9-2
Displaying Diagnostic Parameters.....	9-5
Flowcell Problems.....	9-8
Fluid Problems.....	9-8
Pipe Problems.....	9-9
Transducer Problems.....	9-11
Wetted Transducer Problems.....	9-11
Clamp-on Transducer Problems.....	9-12
Relocating Transducers.....	9-14

Chapter 10: Specifications

Overall.....	10-2
Hardware Configuration.....	10-2
Size/Weight.....	10-2
Enclosure.....	10-2
Flow Accuracy (Velocity, % of reading):.....	10-2
Electrical.....	10-4
Operational Specifications.....	10-6
Transducer.....	10-7
Clamp-On Ultrasonic Flow Transducers.....	10-7
Temperature Transducers.....	10-7
Pipe Size and Material.....	10-8
Clamp-On Transducers:.....	10-8
Available Options.....	10-9

Appendix A: Menu Maps

Appendix B: Measuring P and L Dimensions

Appendix C: Temperature Transmitter Installation

Guidelines for RTD Installation.....	C-2
Mounting RTDs on the Pipe.....	C-2
Assembling the Clamping Fixture.....	C-2
Mounting the RTD to the Pipe.....	C-3
Making Electrical Connections.....	C-4
Connecting the RTD to the 4 to 20-mA Transmitter.....	C-4
Connecting the Transmitter to the PT878.....	C-5

Table of Contents (cont.)

Appendix D: Ultrasonic Thickness Gauge Theory of Operation

Factors Affecting Performance and Accuracy	D-2
--	-----

Appendix E: Material Safety Data Sheet for Couplant

Material Safety Data Sheet	E-2
Section 1— Product Identification	E-2
Section 2 — Hazardous Ingredients	E-2
Section 3 — Physical Data (nominal).....	E-3
Section 4 —Fire and Explosion Hazard Data	E-3
Section 5 — Reactivity Data	E-3
Section 6 — Health Hazard and First Aid Data	E-4
Section 7 —Storage and Handling Information	E-4
Section 8 — Control Measures	E-5

Appendix F: Establishing IR Communications with the PT878

Windows 2000/XP.....	F-2
Windows NT4.0	F-2
Windows Me/98SE/98/95.....	F-2

Appendix G: Glossary

Chapter 1

Features and Capabilities

The TransPort® Model PT878 is a transit-time flowmeter which combines all the features of a full-size flowmeter with the advantages of a portable instrument.

This section describes the TransPort features and general system, and explains the theory of operation.

Overview

The PT878 measures the flow rate of acoustically conductive single-phase fluids. This includes most clean liquids, sewage, some slurries, some oil/water mixtures, and liquids with a small percentage of entrained gas bubbles. The flowmeter provides one linear (0/4-20 mA) analog output of flow velocities or volumetric flow rate of these fluids, measuring velocities from ± 0.03 to ± 12 m/sec (± 0.1 to ± 40 ft/sec), along with one selectable frequency output or pulsed totalizer output.

The PT878 also provides two 4 to 20-mA analog inputs in order to connect temperature transmitters to measure energy flow rate of liquids. Energy flow rate may be calculated for water, glycol, and water/glycol mixtures.

Overview (cont.)

The PT878 has the ability to store site data in files which can be accessed at a later time. Within the Main Menu, a set of forms (windows) asks you all the necessary setup information for a particular site. Once you complete answering the necessary questions, you simply save the information to a file.

The PT878 stores these files and other data in non-volatile memory, which retains the information even if power is off. The flowmeter itself runs on rechargeable or alkaline batteries for up to 10 hours.

This small lightweight flowmeter displays measurements in both numeric and graphical form on a EL-backlit, 240 x 200 pixel LCD graphic screen. The PT878 also has the capability of logging over 100,000 flow data points internally.

Using an infrared communications port, the PT878 can transmit or print logged data, as well as real time data and other stored data. It is also computer-programmable via GE Infrastructure Sensing's PanaView™ software.

To assist you, the PT878 is fully equipped with context-sensitive on-line help which is accessible at any time by simply pressing the "?" (Help) key. Internal diagnostic and troubleshooting features help isolate and remedy common flowcell and transducer problems.

The PT878 operates with all standard GE Infrastructure Sensing transducers - wetted, clamp-on, hybrids (Pan-Adapta® plug), and buffered styles.

A built-in ultrasonic thickness gauge capability measures the pipe wall thickness when used with the optional thickness transducer.

System Description

The PT878 is one part of the flowmeter system. The flowmeter system consists of two essential subsystems: the flowcell and the electronics package (the PT878).

The Flowcell

The flowcell is that part of the system that uses ultrasonic pulses to interrogate the flow. It consists of the flowcell pipe and the transducers.

- A. FLOWCELL PIPE** - The flowcell can either be created in the existing piping (for example, by inserting wetted transducers into the pipe, or clamping non-wetted transducers onto the pipe), or inserted as a substitute pipe section (spoolpiece). The flowcell must provide mechanical support for the transducers and assure stable fluid conditions for accurate flow measurement.
- B. TRANSDUCERS** - The transducers convert electrical energy into ultrasonic pulses when in a transmit cycle, and convert the ultrasonic pulses back to electrical energy when in a receive cycle. In other words, they act like loudspeakers when transmitting the signal and microphones when receiving it. In the PT878 system, each transducer acts as both a receiver and transmitter, since a series of ultrasonic pulses are alternately sent upstream and then downstream through the flowcell.

Electronics Package

The PT878 consists of circuits that generate, receive, and measure the travel time of the ultrasonic pulses. It also contains a microcomputer that controls operation and calculates flow measurement parameters. Specific circuits function as follows:

- **TRANSMIT SIGNAL GENERATOR** - The transmit signal generator, under control of the microcomputer and timing circuit, synthesizes the signal that drives the transmitter.
- **TRANSMITTER** - The transmitter amplifies the signals from the transmit signal generator to a signal that drives the transmit transducer.
- **RECEIVER** - The receiver amplifies the received signals to a level suitable for the data acquisition circuitry.
- **DATA ACQUISITION** - The data acquisition circuitry digitizes the received signal and stores it in a buffer for processing by the microcomputer.
- **TIMING CIRCUIT** - The timing circuit generates the transmitter frequency, receive window, controls the data acquisition circuit and the direction of the transmission.
- **MICROCOMPUTER** - The microcomputer controls the PT878 flowmeter's operation and calculates flow measurements derived from the transmitted and digitized received signals. Also, the microcomputer continually checks for faults and allows the use of built-in diagnostics for troubleshooting.
- **INPUT/OUTPUT** - The input/output circuitry allows the flowmeter to indicate the measured flow with the 0/4-20 mA current loop, and to output to a printer or other remote device. The digital output supports frequency or pulse output, as well as use as a gate input; it can also act as a test point for triggering an oscilloscope from the transmit or receive window.

Theory of Operation

The PT878 is a transit-time ultrasonic flowmeter. When ultrasonic pulses are transmitted through a moving liquid, the pulses that travel in the same direction as the fluid flow (downstream) travel slightly faster than the pulses that travel against the flow (upstream). The PT878 uses various digital signal processing techniques, including cross-correlation, to determine transit times and then uses the transit times to calculate flow velocity.

During operation, two transducers serve as both ultrasonic signal generators and receivers. When mounted on a pipe, they are in acoustic communication with each other, so that each transducer can receive ultrasonic signals transmitted by the other transducer. Each transducer thus functions as a transmitter generating a certain number of acoustic pulses, and as a receiver for an identical number of pulses.

The flowmeter measures the time interval between transmission and reception of the ultrasonic signals in both directions. When the liquid in the pipe is not flowing, the transit-time downstream equals the transit-time upstream. When the liquid is flowing, the transit-time downstream is less than the transit-time upstream. The difference between the downstream and upstream transit-times is proportional to the velocity of the flowing liquid, and its sign indicates the direction of flow.

Chapter 2

Initial Setup

Before making measurements, you must prepare the PT878 for operation. This includes the following procedures:

- Making Electrical Connections
- Charging and/or Replacing Batteries
- Powering On and Off
- Using the Screen and Keypad
- Obtaining On-Line Help

Figure 2-1 below shows the PT878 in its specially designed case. The interior is molded for optimal protection of the PT878 and its accessories.



Figure 2-1: The PT878 and Accessories

Making Electrical Connections

Before making measurements with the PT878, you must make all the necessary connections to the unit. This section describes how to connect the following:

- Power
- Transducers
- Input/Output
- Infrared Interface

Make all connections to the top of the PT878 unit as shown in Figure 2-2 below. Please note that you only need to make the proper power and transducer connections. The other connections are required for particular functions, but are not necessary for basic operation.

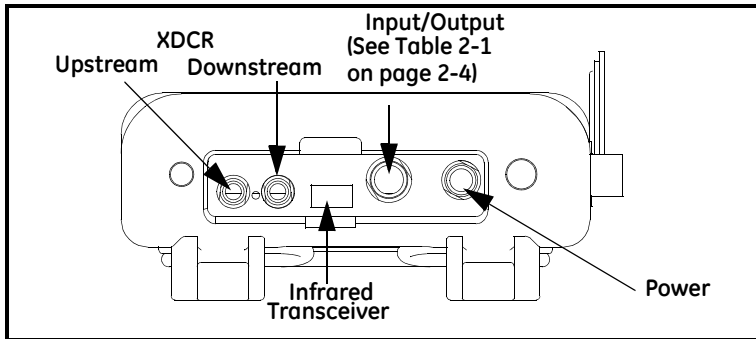

Figure 2-2: Connection Locations

Power Connections

The PT878 is powered by either a 100-120/200-260 VAC wall mount plug-in module, or by 5 internal C_s-size NiCad high-energy rechargeable batteries or by a pack of 3.0 Ahr NiMH batteries. (An optional power supplement, part #703-1283, uses 6 AA alkaline batteries.) When you receive the PT878, the batteries are not charged; therefore, to make remote measurements using the batteries, follow the instructions on page 2-5 to charge the batteries. In either case, you must connect the power cord to the appropriate terminal as shown in Figure 2-2 on the previous page.

!WARNING!

To ensure the safe operation of the PT878, you must install and operate it as described in this manual. In addition, be sure to follow all applicable safety codes and regulations for installing electrical equipment in your area.

Transducer Connections

The transducer cables connect to the PT878 with LEMO[®] coaxial type connectors. Each color-coded cable should have a collar labeled UPSTREAM or DOWNSTREAM. Make transducer cable connections to the top of the flowmeter as shown in Figure 2-2 on page 2-2. Because there are various types of transducers and installations, transducer installation is discussed separately in the *Liquid Transducer Installation Guide* (916-055).

Input/Output Connections

The PT878 provides one 0/4-20 mA current output and two 4 to 20-mA analog inputs with switchable 16-V supply for loop-powered temperature transmitters. It also supports digital, frequency, and totalizer outputs. Connect the inputs/outputs using a LEMO[®] multi-pin connector as shown in Figure 2-2 on page 2-2. The pin numbers for the connector and the color code for the standard input/output cable are shown in Table 2-1 on the next page.

Input/Output Connections (cont.)

Table 2-1: Cable Assembly for Analog Inputs/Outputs

Pin Number	Wire Color	Description
1	Black	Analog Out 1
2	Red	16 V (switched)
3	White	Supply or Return Temperature (Input A)
4	Yellow	Supply or Return Temperature (Input B)
5	Green	Analog Ground
6	Orange	Digital Output (frequency output, pulse totalizer, diagnostic output or calibration gate)
7	Blue	Digital Ground
8	Violet	Receive Monitor

The Infrared Wireless Interface

The PT878 comes equipped with an internal infrared transceiver (shown in Figure 2-2 on page 2-2) that enables communication between the meter and other IR devices, particularly the IR ports or dongles (IR to RS232 adapters) of Windows[®]-based PCs. Users can send and receive site and log data; they can also program the meter via the optional PanaView software interface. The PT878 was designed for use with products that comply to the IrDA protocol. For more information on establishing IR communications between the PT878 and your PC, refer to Appendix F.

- To transfer files between the PT878 and PC, see *Managing Files — the Drive Manager* on page 5-14.
- To transfer a log from the PT878 to a PC, see page 7-14.

Charging and/or Replacing Batteries

The PT878 comes with self-contained, built-in rechargeable batteries to support portable operation. For optimum performance, these batteries require a minimum of maintenance.









Charging the Batteries

When you receive the PT878, you will need to initially charge the batteries. The batteries must be charged up to 8 hours to receive the maximum charge. When fully charged, the batteries provide 8 to 10 hours of continuous operation. An internal battery gauge indicates the remaining power in the batteries.

To charge the batteries, simply plug the AC power module cord into the power jack (shown in Figure 2-2 on page 2-2) and be sure the battery pack is installed. When the PT878 is plugged into line voltage, the internal battery charger automatically charges the batteries, whether the PT878 is on or off. If the PT878 is on, the Battery icon in the upper right corner of the screen indicates battery status (as shown in Table 2-2 below).

Note: *For version 1B of the PT878 software, you must also press the red power key in the upper right corner of the keypad. (See page 5-22 to determine your software version.)*

Table 2-2: Battery Status Icons

Icon	Battery Status
	Full battery
	Partially full battery
	Empty battery
	Fully charged battery, connected to AC power
	Charging battery
	Discharging battery
	Failure/missing battery
	Notification to check battery form (see page 6-4)

Replacing the Batteries

Caution!

Replace batteries only with the specified rechargeable batteries. The battery charges when the unit is off. Do not attempt to recharge non-rechargeable batteries.

If you need to replace the rechargeable batteries, use 5 C_s-size NiCad high energy rechargeable batteries (GE Infrastructure Sensing Part Number 200-058) or the recommended 3.0 Ahr NiMH batteries (part number 200-081). To replace the batteries, remove the rubber boot, open the panel located on the back of the PT878 unit, disconnect the batteries, and replace with new ones (see Figure 2-3 below).

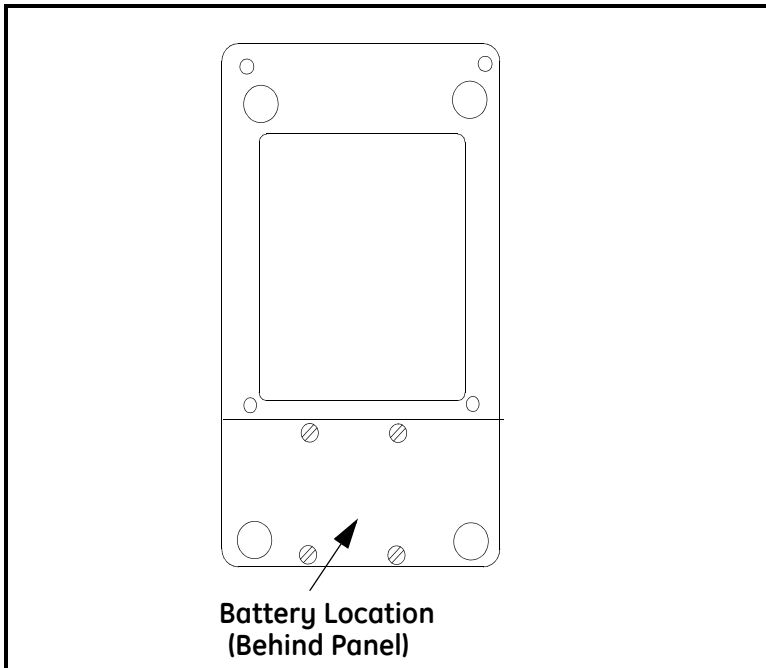

Figure 2-3: Battery Location

To further extend the battery power on the PT878, the GE Infrastructure Sensing Part #705-1283 option uses 6 AA alkaline batteries.

Powering ON and OFF

To operate the PT878, the power cord must be plugged into line voltage or the battery must be charged as described previously.

IMPORTANT: *For CE compliance, the PT878 is classified as a battery-powered device, not to be used with the AC adapter. To comply with CE certification, do not operate the meter with the charger plugged in.*

To turn the PT878 on, press the red button in the upper-right-hand corner of the keypad. Immediately upon power up the PT878 emits a short beep and displays a “PCI Loader” message. It then validates the instrument programming, and then displays the GE Infrastructure Sensing logo and the software version and emits a long beep. If the meter fails any of these tests, contact GE Infrastructure Sensing.

!WARNING!

If the meter fails the backup battery test, you must send the unit back to the factory for a battery replacement. Make sure you keep the batteries charged until you are ready to ship the unit back to the factory. Before shipping, print out all the log and site data, or transfer it to your PC.

Powering ON and OFF (cont.)

After the meter conducts all the self checks, the screen then appears similar to the one shown in Figure 2-4 below.

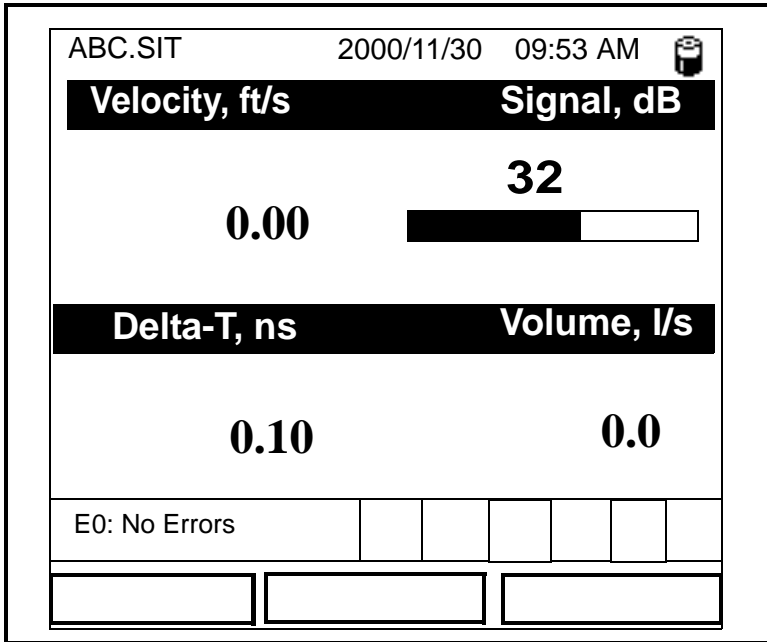

Figure 2-4: Screen After Powering ON

Powering ON and OFF (cont.)

To turn the PT878 off, press the red key for 3 seconds. The screen now appears similar to Figure 2-5 below.

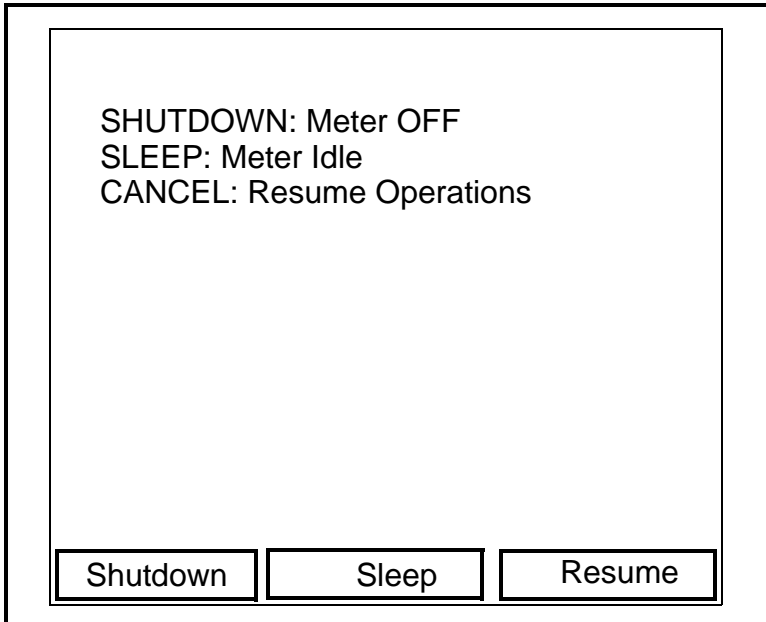

Figure 2-5: The Shutdown Menu

Three options are available:

- Press [F1] to shut down the PT878, turning it completely off.
- Press [F2] to send the PT878 into sleep mode. In this mode, some of the power supplies shut down, but the PT878 remains in a standby mode. Users can resume taking measurements immediately by pressing the power button.
- Press [F3] to cancel the command and return the PT878 to normal operation.

If the PT878 locks up, you can reset it by holding the power key (the red key in the upper right corner) for 15 seconds.

Using the Screen and Keypad

The essential features for operating the PT878 are the screen and keypad. Although these features are common on portable instruments, the PT878 design offers particular features to simplify and speed operation.

Screen

The primary function of the screen is to display information in order for you to accurately and easily take measurements. The PT878 screen consists of seven parts (see Figure 2-6 below).

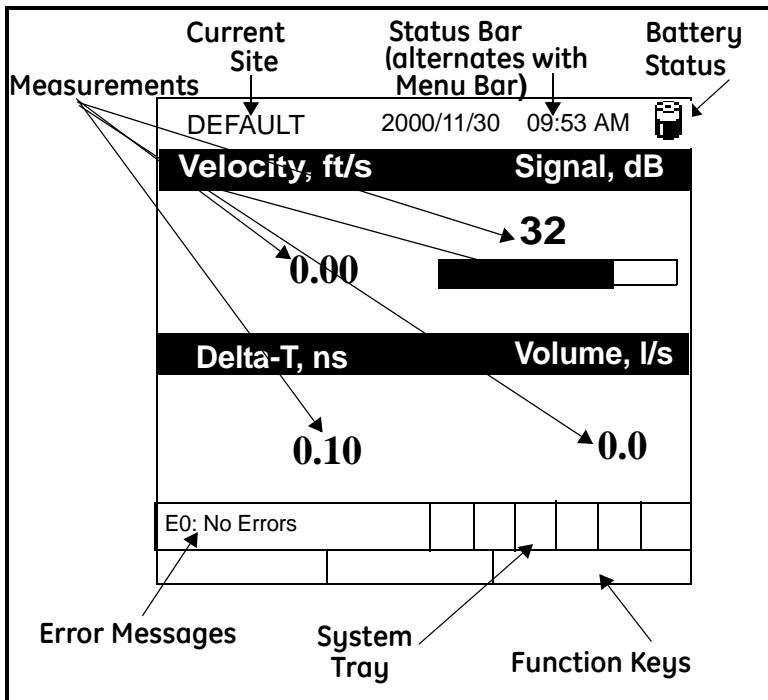

Figure 2-6: The PT878 Screen in Operate Mode







The top line of the screen is the **status bar**, which normally displays the time and date. However, when you press [MENU] (the menu key), the **Menu Bar** replaces the status line.

Screen (cont).

The middle of the screen shown in Figure 2-6 on page 2-10 is the **work area**, which displays the measured parameters, numeric measurements, and both bar and line graphs. (When you enter a selection on the Menu Bar discussed in Chapter 3, *Programming Site Data*, this area displays menu prompts.) A line at the bottom of the area also displays error code messages, which are described in more detail in Chapter 9, *Diagnostics and Troubleshooting*.

The **system tray** displays icons that indicate meter operations not otherwise shown. Table 2-3 below lists the icons and their meanings.

Table 2-3: Icons in the System Tray

Icon	Function	Meaning
	IR Transfer	IR data transfer in progress.
	Alert	Indicates the meter encountered an error in operation.
	Log	Indicates a log is pending (no marks) or running (marks).
	Heating/ cooling	Indicates heating or cooling energy mode.
	Stopwatch	Calibration Gate Operation: Watch is stopped when the gate is closed, or runs when it is open.
 	Snapshot (To file) (To Printer)	Indicates that the Snapshot function has been activated, so users can take screen captures (see page 6-23).

The bottom of the screen displays the three **function key** options: F1, F2 and F3. These keys have different functions, depending on the task you are performing.

Keypad

The PT878 keypad has 25 keys. The functions for each key are as follows (see Figure 2-7 on the next page):

- 3 function keys ([F1], [F2], [F3]) — enable you to select the special functions which appear at the bottom of the screen.
- 12 numeric keys (including - and .) — enable you to enter numeric data.
- 4 arrow keys ([◀], [▶], [▲], [▼]) — enable you to move through the menu options.
- [?] Help key— enables you to access on-line help (discussed on page 2-13).
- [MENU] Menu key — enables you to access the Main Menu.
- [ENTER] — enables you to enter a particular menu, and enters selected values into the PT878 memory.
- [SEL] — enables you to move between data measurements on the screen.
- [ESC] — enables you to exit menus or menu options at any time; cancels a numeric entry.
- Red key [⏻] — turns the power on or off, and toggles the backlight on or off.

Keypad (cont.)

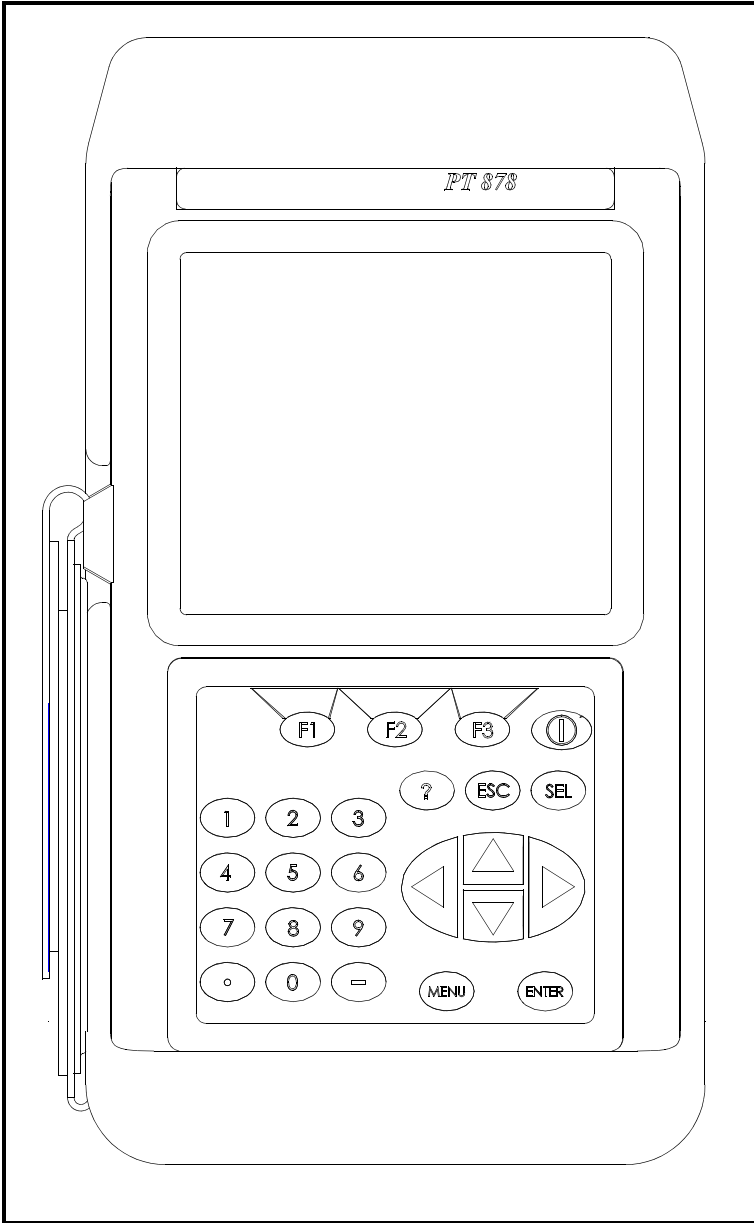

Figure 2-7: The PT878 Keypad

Obtaining On-Line Help

The PT878 offers context-sensitive on-line help screens that describe various features. You can access on-line help at any time by pressing the [?] key. The screen appears similar to Figure 2-8 below.

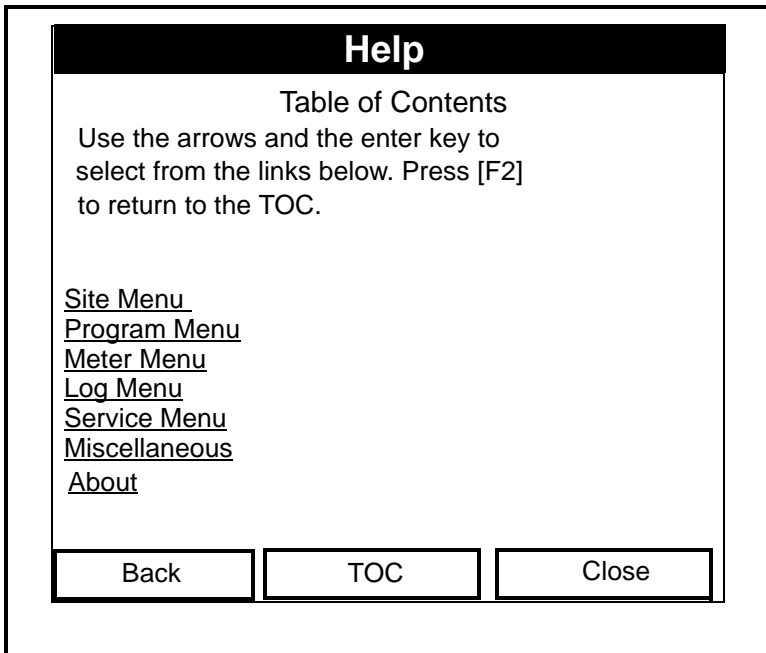

Figure 2-8: The Main Help Menu

Use the three function keys and the [▲] and [▼] arrow keys to navigate to the desired menu, and press [ENTER]. Repeat this procedure to access the desired topic within the menu. When you have finished using the Help menu:

- Press [F1], Back, to move back one level.
- Press [F2], TOC, to return to the Table of Contents.
- Press [F3], Close, to return to the previous screen.

Chapter 3

Programming Site Data

On the PT878, a Program Menu (part of the Main Menu) enables you to enter information that is specific to each site:

- Transducer types and paths
- Pipe materials and linings
- Fluid types
- Heating or cooling energy flow rate
- Analog input and output parameters
- Digital output parameters
- User functions
- Correction factors

For immediate operation, the PT878 requires only transducer, pipe and fluid data. However, additional information allows you to tailor measurements as specifically as possible to your particular application. Once you have entered this data, you can save it in files and recall these files for later use. The PT878 can store up to 1 MB (or 32 site files) of data in the meter at any one time. But through the infrared link, users can store an unlimited number of sites in a PC, and then upload the sites they will actually use.

This chapter covers entering:

- Transducer, pipe, and fluid parameters
- Input/output and other setup parameters
- User functions.

Entering the Program Menu

To enter the Program Menu, press the [MENU] key at the lower right of the PT878 keypad. The Menu Bar replaces the Status Bar at the top of the screen. Press the [▶] arrow key once to scroll from the Site Menu to the Program Menu. At the Program Menu, press [ENTER]. The screen appears similar to Figure 3-1 below. While following the programming instructions, refer to Figure A-3 on page A-3 of Appendix A, *Menu Maps*.

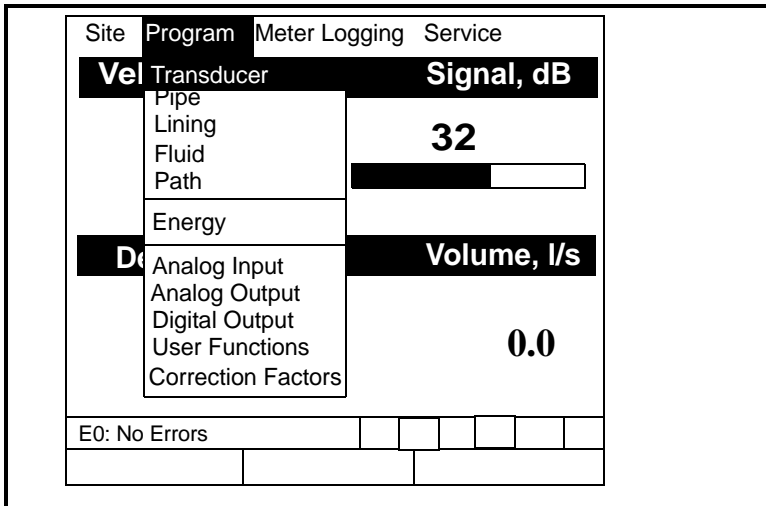

Figure 3-1: The Program Menu

To scroll to a particular option, press the [▼] or [▲] arrow keys until you reach the option. Then press [ENTER] to open the option window.

When entering parameters in an option, press:

- The [▼] key to step through the available parameters
- The [▲] key to scroll back to a previously entered parameter
- The [F2] key (Cancel) or the [ESC] key to exit an option at any time and return to Operate Mode without changing the parameters.

Note: *If you enter an incorrect numeric value, press the [◀] key to erase the last digit entered.*

Entering Transducer Parameters

To enter the Transducer option, scroll to the Transducer entry on the Program Menu and press [ENTER]. The screen appears similar to Figure 3-2 below. To step through each parameter, press the [▼] key. Refer to Figure A-7 on page A-7 of Appendix A, *Menu Maps*.

Note: Refer to the Liquid Transducer Installation Guide (916-055) for additional information about transducers and configurations.

The screenshot shows a window titled "Transducer/Pipe" with several tabs: "Transducer" (selected), "Pipe", "Lining", "Fluid", and "Path". The main area contains the following parameters:

- Type: Wetted Clamp-on
- Transducer:
- Frequency: MHz T_w μ s
- Wedge Ang: °
- Wedge Tmp: °C
- Wedge SS: m/s

At the bottom of the window are two buttons: "Cancel" and "OK".

Figure 3-2: The Transducer Option Window

1. The first prompt asks you to select whether you are using a wetted or a clamp-on transducer.
 - a. Use the [◀] and [▶] keys to scroll between the two types.
 - b. Press [ENTER] to confirm the choice.

Entering Transducer Parameters (cont.)

Note: *The choices made early in the Transducer and Pipe options determine the prompts available later. If the PT878 does not scroll to a particular parameter, it is not necessary for that transducer or pipe type. For example, the Lining window is not available if you select a wetted transducer.*

2. The next prompt asks you to enter the transducer number (printed on the transducer itself), or to specify that you are using a special application transducer.
 - a. From the Type prompt, press the [▼] key to reach the Transducer prompt, and press [ENTER].
 - b. A drop-down list of transducer numbers opens. (The list varies, depending on whether you have selected wetted or clamp-on in the previous prompt.) Press the [▼] or [▲] keys to scroll to the appropriate number, or scroll to “Special” for a special application transducer. To speed scrolling, you can press the [▶] key to scroll down by a page, or the [◀] key to scroll up by a page.
 - c. Press [ENTER] to confirm your selection.

The program now varies, depending on whether you have selected standard or special transducers.

- If you have selected a standard wetted or clamp-on transducer, the PT878 comes programmed with the needed parameters. Proceed to *Confirming Entries* on page 3-6.
- However, if you have selected a special application transducer, go to the next page.

Parameters for Special Transducers

Note: *GE Infrastructure Sensing will supply the information required below with the transducers.*

3. The prompt asks for the transducer frequency, to transmit a signal at a frequency to which the transducer can respond.
 - a. From the Transducer prompt, press the [▼] key to reach the Frequency prompt, and press [ENTER].
 - b. A drop-down list of five frequencies opens, ranging from 0.50 to 4.00 MHz. Scroll to the desired frequency, and press [ENTER].
4. The next prompt asks for T_w , the time delay. This parameter is actually the time the transducer signal spends travelling through the transducer and cable. The PT878 calculates the flow rate from the upstream and downstream transit times in the fluid, so the T_w (time delay) must be subtracted out for an accurate measurement. GE Infrastructure Sensing supplies the time delay on a sheet of paper inside the transducer case.
 - a. From the Frequency prompt, press the [▶] key to reach the T_w prompt, and press [ENTER].
 - b. Use the numeric keys to enter the GE Infrastructure Sensing-supplied time delay and press [ENTER].

The program now varies, depending on whether you have selected a wetted or a clamp-on transducer.

- If you have selected a special wetted transducer, proceed to *Confirming Entries* on the next page.
 - Special clamp-on transducers require three more inputs: wedge angle, wedge temperature, and wedge sound speed.
5. When calculating the flow rate, the PT878 must take into account the wedge angle, the angle of the ultrasonic transmission.
 - a. From the T_w prompt, press the [▼] key to reach the Wedge Angle prompt, and press [ENTER].

Parameters for Special Transducers (cont.)

- b.** Use the numeric keys to enter the GE Infrastructure Sensing-supplied wedge angle (in degrees) and press [ENTER].
 - 6.** The PT878 must also take into account the wedge temperature.
 - a.** From the Wedge Angle prompt, press the [▼] key to reach the Wedge Temperature prompt, and press [ENTER].
 - b.** Use the numeric keys to enter the wedge temperature (in degrees F or C) and press [ENTER].
 - 7.** Finally, the PT878 requires the wedge sound speed.
 - a.** From the Wedge Temp prompt, press the [▼] key to reach the Wedge SS prompt, and press [ENTER].
 - b.** Use the numeric keys to enter the GE Infrastructure Sensing-supplied wedge sound speed (in ft/sec or m/sec) and press [ENTER].

Pressing the [▼] key returns the meter to the Transducer tab at the top.

Confirming Entries

- To confirm the entries and return to Operate mode, press [F3] (OK).
- To leave the window without confirming the entries, press [F2] (Cancel) or the [ESC] key.

In either case, the PT878 returns to Operate Mode.

Entering Pipe Parameters

To enter the Pipe option, scroll to the Pipe entry on the Program Menu and press [ENTER]. (From the Transducer window, you can scroll back up to the Transducer tab and press the [▶] arrow key to reach the Pipe window, and press [ENTER].) The screen appears similar to Figure 3-3 below. To step through each parameter, press the [▼] key. Refer to Figure A-3 on page A-3 of Appendix A, *Menu Maps*.

Note: Refer to the brochure *Sound Speeds and Pipe Size Data* (914-004) for additional information about pipe sizes and sound speeds.

The screenshot shows a software window titled "Transducer/Pipe". At the top, there are five tabs: "Transducer", "Pipe" (which is selected and highlighted in black), "Lining", "Fluid", and "Path". Below the tabs, the "Material" field is set to "Other". The "Sound Speed" field contains the value "600.3" followed by "m/s". A button labeled "Measure Wall with TGauge" is positioned below the sound speed field. Underneath, there are three input fields: "OD, mm" with the value "5", "OD x PI, mm" with the value "15.708", and "Wall, mm" with the value "2". Below these are two more input fields: "Nominal" and "Schedule", both currently empty. To the right of the "Schedule" field is a checkbox labeled "ANSI", which is currently unchecked. At the bottom of the window are two buttons: "Cancel" and "OK".

Figure 3-3: The Pipe Option Window

Entering Pipe Parameters (cont.)

1. The first prompt asks you to select the pipe material.
 - a. Press [ENTER] to enter the material prompt.
 - b. A drop-down list of materials opens. Table 3-1 below lists the available preprogrammed materials on the list. Press the [▼] or [▲] keys to scroll to the appropriate material, or scroll to “Other” for a material not on the list. You can press the [▶] key to scroll down by a page, or the [◀] key to scroll up by a page.

Table 3-1: Preprogrammed Pipe Materials

Pipe Material Category	Specific Material
Al - Aluminum	Rolled
Brass	None
Cu - Copper	Annealed or Rolled
CuNi - Copper/Nickel	70% Cu 30% Ni or 90% Cu 10% Ni
Glass	Pyrex, Flint, or Crown
Gold	Hard-drawn
Inconel	None
Iron	Armco, Ductile, Cast, Electrolytic
Monel	None
Nickel	None
Plastic	Nylon, Polyethylene, Polypropylene, PVC (CPVC), or Acrylic
Steel	Carbon Steel or Stainless Steel
Tin	Rolled
Titanium	None
Tungsten	Annealed, Carbide, Drawn
Zinc	Rolled
Other*	Any material

- c. Press [ENTER] to confirm the choice.

Entering Pipe Parameters (cont.)

- d. If you have selected “Other,” the meter prompts you to enter the sound speed. Use the numeric keys to type the desired sound speed in the text box, and press [ENTER] to confirm the choice.
2. The next prompt asks if you wish to measure the pipe wall with the internal thickness gauge. If you press [ENTER], the program moves to the T-Gauge Display option (as covered on page 8-5). When you have completed setting up and using the thickness gauge (as discussed in Chapter 8), press [F2] or [F3] to return to the Pipe tab.
3. For pipe diameter, two alternatives are available. At the Diameter prompt, the meter asks for the pipe outside diameter and thickness. But if you have selected certain pipe materials (carbon or stainless steel, cast iron, PVC and CPVC), you have the option of entering the pipe dimensions by a standardized schedule. Once you enter the nominal pipe size and identification, the PT878 determines the OD and wall thickness from an internal table.

If you select a material that uses the Diameter alternative:

- a. You must select from two choices, outside diameter or circumference.
 - The prompt moves to the OD (outside diameter) text box. Type the thickness (in mm or in.) into the text box, and press [ENTER] to confirm the choice,

or

 - Move the prompt to the OD X PI (circumference) text box. Type the OD (in mm or in.) into the box, and press [ENTER] to confirm your choice.
- b. In either case, the next prompt asks for the wall thickness. Type the value (in mm or in.) into the box, and press [ENTER] to confirm your choice.

Entering Pipe Parameters (cont.)

Note: *The measurement units shown depend on the choices you have made in the English/Metric window or the Meter Settings menu.*

If you select a material that has the Schedule option:

- a. The prompt asks if you wish to apply ANSI (the ANSI schedule). Press [ENTER] to select (or deselect) the ANSI box. (If you do not select the ANSI option, the prompt moves to the OD text box, and you enter the parameters for the Diameter alternative as discussed above.)
- b. Press the [◀] key twice to move the prompt to the Nominal pipe size drop-down menu. Press [ENTER] to open the menu. Scroll to the desired pipe size, and press [ENTER] to confirm your choice.
- c. Press the [▶] key to move the prompt to the Schedule drop-down menu. Press [ENTER] to open the menu. Scroll to the desired schedule, and press [ENTER] to confirm the choice.

After entering either diameter or schedule settings, pressing the [▲] key returns the meter to the Pipe Material prompt.

- To confirm the entries and return to Operate Mode, press [F3] (OK).
- To leave the window without confirming the entries, press [F2] (Cancel) or the [ESC] key.

In either case, the PT878 returns to Operate Mode.

- To return to the Pipe tab and scroll to other windows, press the [▲] key.

Entering Pipe Lining Parameters

To enter the Lining option, scroll to the Lining entry on the Program Menu and press [ENTER]. (From the Pipe window, you can scroll back up to the Pipe tab and press the [▶] arrow key to reach the Lining window, and press [ENTER].) The screen appears similar to Figure 3-4 below. To step through each parameter, press the [▼] key. While programming, refer to Figure A-8 on page A-8 of Appendix A, *Menu Maps*.

Note: *The Lining option is only available for clamp-on transducers.*

The screenshot shows a window titled "Transducer/Pipe" with five tabs: "Transducer", "Pipe", "Lining", "Fluid", and "Path". The "Lining" tab is selected. Below the tabs, the "Material" is set to "Tar/Epoxy". Below that, "Sound Speed" is set to "2000" m/s, and "Thickness" is set to "0" mm. At the bottom of the window are two buttons: "Cancel" and "OK".

Figure 3-4: The Pipe Lining Window

1. The PT878 first prompts you to select the pipe lining material.
 - a. Press [ENTER] to open the drop-down list of lining materials.
 - b. Scroll to the appropriate material. If you do not see your lining material on the list, select "Other."
 - c. Press [ENTER] to confirm your choice.

Entering Pipe Lining Parameters (cont.)

Note: *If your pipe lining is not on the drop-down list, consult GE Infrastructure Sensing for further information.*

2. The menu now follows one of two paths:
 - If you have selected a preprogrammed material, the PT878 automatically supplies the correct sound speed, and you can proceed to step 3.
 - If you have selected “Other,” the meter prompts you to enter the sound speed. Use the numeric keys to type the desired sound speed in the text box, and press [ENTER] to confirm the choice.
3. The meter now asks for the lining thickness. Use the numeric keys to enter the desired value in the text box, and press [ENTER] to confirm your entry.

Pressing the [▼] key returns the meter to the Lining tab.

- To confirm the entries and return to Operate Mode, press [F3] (OK). The PT878 returns to Operate Mode.
- To leave the window without confirming the entries, press [F2] (Cancel) or the [ESC] key. The PT878 returns to Operate Mode.
- To scroll to other windows, press the [◀] or [▶] key. Your changes will remain until you select OK or Cancel from one of the tabbed windows in the Transducer/Pipe form.

Entering Fluid Types and Speeds

To access the Fluid option, scroll to the Fluid entry on the Program Menu and press [ENTER]. (If you are already in the Transducer/Pipe form, press the [▶] arrow key to reach the Fluid window, and press [ENTER].) The screen appears similar to Figure 3-5 below. To step through each parameter, press the [▼] key. Refer to Figure A-9 on page A-9 of Appendix A, *Menu Maps*.

Transducer/Pipe

Transducer Pipe Lining **Fluid** Path

Tracking Windows? No Yes

Fluid

Sound Speed m/s

Speed Min m/s

Speed Max m/s

Temp °F Glycol %

Cancel OK

Figure 3-5: The Fluid Type Window

1. The first prompt asks you to select whether or not you want Tracking Windows. These windows are used to detect the receive signal when you are unsure of the fluid sound speed. (Default operation is “No.”)
 - a. Use the [◀] and [▶] keys to scroll to the appropriate radio button.
 - b. Press [ENTER] to confirm your selection.

Entering Fluid Types and Speeds (cont.)

2. Next, you must select the fluid type.
 - a. Press [ENTER] to open the drop-down menu. Table 3-2 below lists the available choices, which vary with your selection of Tracking Windows or the Energy option.

Table 3-2: Fluid Type Selection

	Tracking Windows Off	Tracking Windows On
Energy Off	Other	Water (0-260°C)
	Water (0-260°C)	Oil
	Sea Water	Other
	Oil (22°C)	
	Crude Oil	
	Lube Oil (X200)	
	Methanol	
	Ethanol	
	LN2 (-199°C)	
	Freon (R-12)	
Energy On	Water/0-260°C	Water/0-260°C
	Water/Glycol (with glycol percentage)	Water/Glycol (with glycol percentage)
	Other (with single soundspeed)	Other (with minimum and maximum soundspeeds)

- b. Scroll to the appropriate fluid. If you do not see your fluid on the list, select “Other.”

Note: Depending on your selection, additional prompts may appear, as specified in Table 3-2 above.

- c. Press [ENTER] to confirm your selection.

Entering Fluid Types and Speeds (cont.)

At the end of any sequence, pressing the [▼] key returns you to the Tracking Windows prompt.

- To confirm the entries and return to Operate Mode, press [F3] (OK). The PT878 returns to Operate Mode.
- To leave the window without confirming the entries, press [F2] (Cancel) or the [ESC] key. The PT878 returns to Operate Mode.
- To scroll to other windows, press the [◀] or [▶] key.

Entering the Signal Path Parameters

To enter the Path option, scroll to the Path entry on the Program Menu and press [ENTER]. (From the Lining window, you can scroll back up to the Lining tab and press the [▶] arrow key to reach the Path window, and press [ENTER].) The screen appears similar to Figure 3-6 below. To step through each parameter, press the [▼] key. Refer to Figure A-10 on page A-10 of Appendix A, *Menu Maps*.

The screenshot shows a window titled "Transducer/Pipe" with four tabs: "Transducer", "Pipe", "Lining", and "Path". The "Path" tab is selected. Inside the window, there are four input fields with labels and units:

- Path Length: mm
- Axial Length: mm
- Traverses:
- Spacing: mm

At the bottom of the window are two buttons: "Cancel" and "OK".

Figure 3-6: The Signal Path Window

The prompts available for the Path option depend on whether you have selected clamp-on or wetted transducers in the Transducer menu. (If the PT878 does not scroll to a particular parameter, it is not necessary for that transducer type.)

Path Parameters for Clamp-On Transducers

Note: *For wetted transducers, go to the next page.*

If you are using clamp-on transducers, the PT878 path menu includes two parameters:

- Traverses
 - Spacing
1. The PT878 first prompts for traverses, the number of times the ultrasonic signal crosses the pipe (see the *Liquid Transducer Installation Guide* (916-055) for more details).
 - a. Press [ENTER] to open the drop-down list of traverse numbers.
 - b. Scroll to the appropriate number.
 - c. Press [ENTER] to confirm the entry.
 2. The next prompt displays the spacing of the transducers, as calculated from the information entered.
 - a. Record this number and use it to space the transducers. (Use the *Liquid Transducer Installation Guide* (916-055) to assist in installing transducers on the pipe.) Press the [▼] key to scroll to the next parameter.
 - b. If necessary, you can overwrite the spacing to match the actual physical spacing of the transducers. (Do not change the spacing by more than $\pm 10\%$ from that calculated by the meter.) Use the numeric keys to enter the desired value, and press [ENTER] to confirm the entry. If you have entered an invalid entry, the PT878 rejects the entry and displays an error message.

Note: *It is not recommended that you use a spacing other than the one calculated by the PT878.*

After you enter the spacing, pressing the [▲] key returns the prompt to the Traverses box, and then to the Path tab at the top of the screen.

Path Parameters for Wetted Transducers

If you are using wetted transducers, the PT878 path menu includes the following set of parameters:

- Path Length
 - Axial Length
1. The meter first prompts for the path length (P) of the ultrasonic signal. GE Infrastructure Sensing has calculated the path length based on the transducer configuration for your particular application. Find the path length on the flowcell or on other supplied documentation.
 - a. Press [ENTER] to enter the text box.
 - b. Use the numeric keys to enter the appropriate number.
 - c. Press [ENTER] to confirm the entry.

Note: *If the documentation does not supply the path or axial lengths, refer to Appendix B, Measuring P and L Dimensions, to measure these lengths.*

2. The next prompt asks for the axial dimension (L) of the ultrasonic signal. Again, GE Infrastructure Sensing has calculated the axial dimension based on the transducer configuration for your particular application. Find the axial dimension on the flowcell or from other supplied documentation.
 - a. Press [ENTER] to enter the text box.
 - b. Use the numeric keys to enter the appropriate number.
 - c. Press [ENTER] to confirm the entry.

After you enter the axial length, press the [▲] key to return to the main Path tab at the top of the screen.

- To confirm the entries and return to Operate Mode, press [F3] (OK). The PT878 returns to Operate Mode.
- To leave the window without confirming the entries, press [F2] (Cancel) or the [ESC] key. The PT878 returns to Operate Mode.
- To scroll to other windows, press the [◀] or [▶] key.

Entering the Energy Option Parameters

The Energy Option enables you to calculate the energy of a system based on the temperature at a supply point, the temperature at a return point, and the flow of fluid through the system. To enter the Energy Option, scroll to the Energy entry on the Program Menu and press [ENTER]. The screen appears similar to Figure 3-7 below. To step through each parameter, press the [▼] key. While programming, refer to Figure A-11 on page A-11 of Appendix A, *Menu Maps*.

The screenshot shows a window titled "Energy Options" with three tabs: "Energy Option", "Inputs", and "Custom Cp". The "Energy Option" tab is selected. The window contains the following settings:

- Energy:** Disabled, Enabled
- System:** Heating, Cooling
- Flow Measurement at:** Supply, Return
- Calculation Method:** Standard, Custom Cp

At the bottom of the window are two buttons: "Cancel" and "OK".

Figure 3-7: The Energy Option Window

1. The first prompt asks if you want to disable or enable the Energy Option.
 - a. Use the [◀] and [▶] keys to scroll to the appropriate radio button.
 - b. Press [ENTER] to confirm your selection.

Note: *If you select “Disabled,” you cannot select any other prompt in this window.*

Entering the Energy Option Parameters (cont.)

2. The next prompt asks if you are using a heating or cooling system.
 - a. Use the [◀] and [▶] keys to scroll to the appropriate radio button.
 - b. Press [ENTER] to confirm your selection.
3. The program now asks if you are measuring flow at the point of supply or return.
 - a. Use the [◀] and [▶] keys to scroll to the appropriate radio button.
 - b. Press [ENTER] to confirm your selection.
4. The final prompt asks if you wish to use the standard or Custom Cp method for energy calculations. If you choose Custom Cp, you must enter tables for fluid enthalpy and density in the Custom Cp tab (see page 3-24).
 - a. Use the [◀] and [▶] keys to scroll to the appropriate radio button.
 - b. Press [ENTER] to confirm your selection.

Pressing the [▲] key returns the meter to the Energy prompt, and then to the Energy Option tab.

- To confirm the entries and return to Operate mode, press [F3] (OK). The PT878 returns to Operate Mode.
- To leave the window without confirming the entries, press [F2] (Cancel) or the [ESC] key. The PT878 returns to Operate Mode.

Entering Inputs in the Energy Option

To enter input parameters in the Energy Option, return to the Energy Option tab at the top of the Energy Option window. Press the [▶] arrow key to reach the Inputs window, and press [ENTER]. The screen appears similar to Figure 3-8 below. To step through each parameter, press the [▼] key.

IMPORTANT: *The supply and return must be on separate inputs.*

Energy Options

Energy Option **Inputs** Custom Cp

Supply
 Fixed Active

Temp °C Input #

T Return
 Fixed Active

Temp °C Input #

Cancel OK

Figure 3-8: The Inputs Tab in the Energy Option

1. The first prompt asks if the temperature supply is fixed or active.
 - a. Use the [◀] and [▶] keys to scroll to the appropriate radio button.
 - b. Press [ENTER] to confirm your selection.

Entering Inputs in the Energy Option (cont.)

- 2.** The next prompt depends on whether you have selected a fixed or an active supply.
 - If you have selected a fixed supply, the PT878 asks for the desired temperature. Use the numeric keys to enter the desired temperature (in degrees C), and press [ENTER] to confirm the entry.
 - If you have selected an active supply, the PT878 asks for the desired input.
 - a.** Press [ENTER] to open the drop-down menu.
 - b.** Scroll to Input A or B.
 - c.** Press [ENTER] to confirm the entry.
- 3.** The next prompt asks if the temperature return is fixed or active.
 - a.** Use the [◀] and [▶] keys to scroll to the appropriate radio button.
 - b.** Press [ENTER] to confirm your selection.
- 4.** The next prompt depends on whether you have selected a fixed or an active return.
 - If you have selected a fixed return, the PT878 asks for the desired temperature. Use the numeric keys to enter the desired temperature (in degrees C), and press [ENTER] to confirm the entry.
 - If you have selected an active return, the PT878 asks for the desired input.
 - a.** Press [ENTER] to open the drop-down menu.
 - b.** Scroll to Input A or B.
 - c.** Press [ENTER] to confirm the entry.

Entering Inputs in the Energy Option (cont.)

Note: *If either input is fixed, the analog input(s) not used by the Energy Option can act as general-purpose inputs.*

Pressing the [▼] key returns the meter to the Inputs tab.

- To confirm the entries and return to Operate mode, press [F3] (OK). The PT878 returns to Operate Mode.
- To leave the window without confirming the entries, press [F2] (Cancel) or the [ESC] key. The PT878 returns to Operate Mode.

To enter data for Custom Cp calculations, proceed to the Custom Cp tab, discussed on the next page.

Entering Custom Cp Data in the Energy Option

To program Custom Cp tables in the Energy Option, return to the tabs at the top of the Energy Option window. Press the [▶] arrow key until you have highlighted the Custom Cp tab, and press [ENTER]. The screen appears similar to Figure 3-9 below. To step through each parameter, press the [▼] key.

Figure 3-9: The Custom Cp Tab in the Energy Option

1. The first prompt asks if you wish to enter or edit data in the Custom Cp (enthalpy) table.
 - a. Press [ENTER] to open the Custom Cp table, shown in Figure 3-10 on the next page.
 - b. Use the numeric keys to enter the desired temperature in degrees Kelvin, and press [ENTER] to confirm the entry.
 - c. Press the [▶] key to move to the kJ/kg/°K column (enthalpy in KiloJoules/Kilogram/°Kelvin). Use the numeric keys to enter the desired value, and press [ENTER].

Entering Custom Cp Data in the Energy Option (cont.)

Custom Cp		
	°Kelvin	kJ/kg/°K
1		
2		
3		
4		
5		

Figure 3-10: The Custom Cp (temperature vs. enthalpy) Table

- d. Repeat steps b and c for the remainder of the table.
 - e. When you have completed entering values, press [F3] (OK) to confirm the table and return to the Custom Cp window.
2. The next prompt asks from which source — a fixed value or table — the PT878 will use for fluid density values. Use the [◀] and [▶] keys to scroll to the appropriate radio button, and press [ENTER].
 3. The menu now varies, depending on your selection in step 2.
 - If you selected “Fixed,” the PT878 asks for the fixed fluid density. Use the numeric keys to enter the desired value, and press [ENTER].
 - If you selected “Table,” the meter highlights the “Edit Table” button.

Entering Custom Cp Data in the Energy Option (cont.)

Edit Density		
<input type="text"/>		
	°Kelvin	kg/m ³
1		
2		
3		
4		
5		

Figure 3-11: The Fluid Density Table

- a. Press [ENTER] to open the Edit Density table, shown in Figure 3-11 above.
 - b. Use the numeric keys to enter the desired temperature in degrees Kelvin, and press [ENTER].
 - c. Press the [▶] key to move to the kg/m³ column (density in Kilogram/cubic meters). Use the numeric keys to enter the desired value, and press [ENTER].
 - d. Repeat steps b and c for the remainder of the table.
 - e. When you have completed entering up to 20 values, press [F3] (OK) to confirm the table and return to the Custom Cp window.
- To confirm the entries and return to Operate mode, press [F3] (OK). The PT878 returns to Operate Mode.
 - To leave the window without confirming the entries, press [F2] (Cancel) or the [ESC] key. The PT878 returns to Operate Mode.

Entering Analog Inputs

The Analog Input option enables you to specify parameters for general purpose or energy inputs. To enter the Inputs option, scroll to the Analog Input entry on the Program Menu and press [ENTER]. If you have not enabled the Energy Option (see page 3-19), the screen appears similar to Figure 3-12 below. To step through each parameter, press the [▼] key. Refer to Figure A-12 on page A-12 of Appendix A, *Menu Maps*.

Entering General-Purpose Analog Inputs

The screenshot shows a window titled "Analog Input" with two tabs, "Input A" and "Input B". The "Input A" tab is active. Inside the window, there are five rows of input fields:

- Function: A dropdown menu showing "General Purpose".
- Label: A text box containing "Inlet Temp".
- Units: A text box containing "*C".
- Zero: A text box containing "0" followed by "°C".
- Span: A text box containing "100" followed by "°C".

At the bottom of the window are two buttons: "Cancel" and "OK".

Figure 3-12: The Analog Inputs Option Window

1. The first prompt asks you to select whether the desired function is off or general purpose.
 - a. Press [ENTER] to open the drop-down menu.
 - b. Scroll to the desired response.
 - c. Press [ENTER] to confirm your selection.

Entering General-Purpose Analog Inputs (cont.)

2. The next prompt asks if you want to label the input.

- a. Press [ENTER] to enter the text box. The text creation window appears, as shown in Figure 3-13 below.

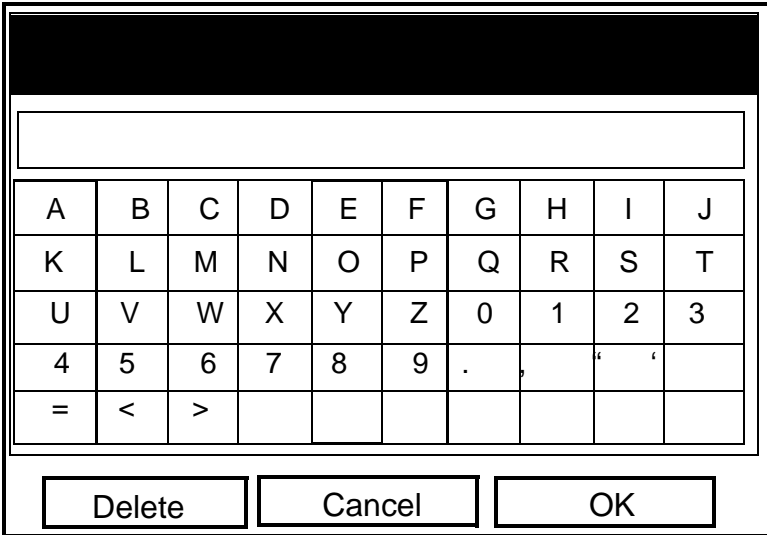

Figure 3-13: The Text Creation Window

- b. Use the four arrow keys to scroll to the desired letter or symbol, and press [ENTER] to add the letter to the name.

Note: *Pressing [SEL] causes the screen to show successively a set of upper-case (capital) letters, a set of lower-case letters, and a set of symbols. Use all three screens to create a desired label.*

- c. Repeat this procedure for each letter or symbol you wish to add to the name. If you wish to delete a letter, press [F1] (Delete) to erase each letter or symbol, from right to left on the label.
- d. When you have completed the label, press [F3] (OK) to confirm the label, or [F2] (Cancel) to leave the window without adding the label.

Entering General-Purpose Analog Inputs (cont.)

3. The next prompt asks you to create a label for the units, if desired. (This label will appear to the right of the zero and span value boxes.) Press [ENTER] to reopen the text creation window, and follow the same steps covered in Step 2 on the previous page.
4. The next prompt asks for the zero input value.
 - a. Press [ENTER] to enter the text box.
 - b. Use the numeric keys to enter the desired value.
 - c. Press [ENTER] to confirm the entry.
5. The final prompt asks for the span input value.
 - a. Press [ENTER] to enter the text box.
 - b. Use the numeric keys to enter the desired value.
 - c. Press [ENTER] to confirm the entry.

You have completed entering data for general-purpose inputs.

Entering Analog Inputs in the Energy Option

If you have enabled the Energy Option, the screen displays fewer options, as shown in Figure 3-14 below.

The screenshot shows a window titled "Analog Input" with two tabs: "Input A" and "Input B". The "Input A" tab is selected. Inside the window, there are five rows of configuration options, each with a text box to its right:

- Function: Supply Temp
- Label: Supply Temp
- Units: °C
- Zero: 0 °C
- Span: 100 °C

At the bottom of the window, there are two buttons: "Cancel" and "OK".

Figure 3-14: The Analog Inputs Option Window, with the Energy Option Activated

Entering Analog Inputs in the Energy Option (cont.)

The screen displays the function (supply or return temperature), label (supply or return temperature) and units selected in the Inputs form of the Energy Option (see page 3-21). You cannot change these parameters in this form. Press the [▼] key to step through these parameters.

- 1.** The first prompt asks for the zero input value.
 - a.** Press [ENTER] to enter the text box.
 - b.** Use the numeric keys to enter the desired value.
 - c.** Press [ENTER] to confirm the entry.
- 2.** The final prompt asks for the span input value.
 - a.** Press [ENTER] to enter the text box.
 - b.** Use the numeric keys to enter the desired value.
 - c.** Press [ENTER] to confirm the entry.

You have completed entering parameters in the Analog Inputs option.

- To confirm the entries and return to Operate mode, press [F3] (OK). The PT878 returns to Operate Mode.
- To leave the window without confirming the entries, press [F2] (Cancel) or the [ESC] key. The PT878 returns to Operate Mode.

Entering the Analog Output

The Analog Output option enables you to enter information to set up output parameters. To enter the option, scroll to the Analog Output entry on the Program Menu and press [ENTER]. The screen appears similar to Figure 3-15 below. To step through each parameter, press the [▼] key. Refer to Figure A-13 on page A-13 of Appendix A, *Menu Maps*.

Analog Output	
Function	0-20 mA
Data Source	Velocity Meters/sec
Zero	0 m/s
Span	25.5 m/s
On Error	Hold Last Value

Cancel OK

Figure 3-15: The Analog Output Window

1. The first prompt enables you to select a range to send a current signal to a recording device.
 - a. Press [ENTER] to open the drop-down menu.
 - b. Scroll to the desired output from three choices: Off, 0-20 mA, and 4-20 mA.
 - c. Press [ENTER] to confirm your selection.

Note: *If you select “Off,” you will not be able to access any other parameters in this option.*

Entering the Analog Output (cont.)

- The next prompt asks you to select the analog output type from a list of choices, as shown in Figure 3-16 below.

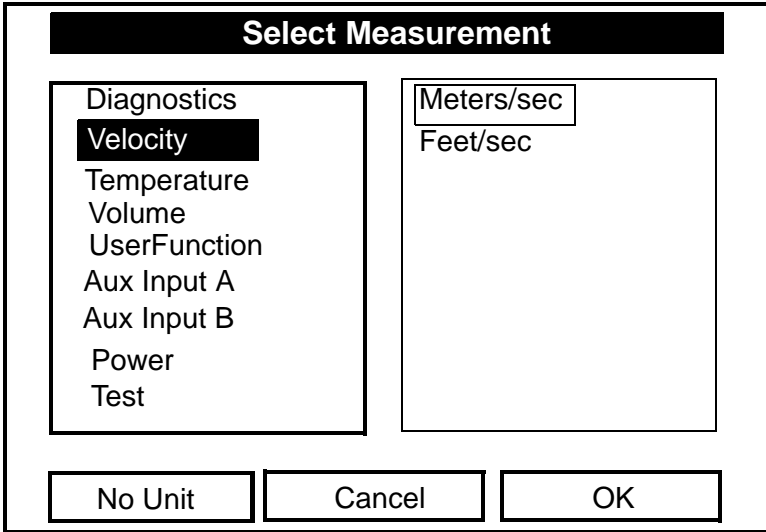

Figure 3-16: Data Source Selection Window

- Press [ENTER] to open the window.
- Scroll to the desired output type.
- Press [SEL] to confirm your selection.
- The prompt then moves to a list of unit types. (The available units depend on the selection made at the Data Source prompt.) Scroll to the desired output unit.
- Press [F3] (OK) to confirm your selection.

Entering the Analog Output (cont.)

3. The next prompt asks you to enter the zero (base) value for the analog output. This value represents the 0/4 mA output (in flow units).
 - a. Press [ENTER] to open the text box.
 - b. Use the numeric keys to enter the desired value.
 - c. Press [ENTER] to confirm your selection.

4. The next prompt asks you to enter the span (full scale) value for the analog output. This value represents the 20 mA output (in flow units).
 - a. Press [ENTER] to open the text box.
 - b. Use the numeric keys to enter the desired value.
 - c. Press [ENTER] to confirm your selection.

5. The last prompt, On Error, asks you to select how the PT878 will handle the analog outputs in the event of a fault condition. The meter offers three alternatives:
 - Hold Last Value (hold the last good reading)
 - Force Low (force the reading to 0 or 4 mA)
 - Force High (force the reading to 20 mA).
 - a. Press [ENTER] to open the drop-down menu.
 - b. Scroll to the desired selection.
 - c. Press [ENTER] to confirm your selection.

You have completed entering data in the Analog Output option.

- To confirm the entries and return to Operate mode, press [F3] (OK). The PT878 returns to Operate Mode.
- To leave the window without confirming the entries, press [F2] (Cancel) or the [ESC] key. The PT878 returns to Operate Mode.

Entering the Digital Output

While resembling the Analog Output option, the Digital Output option enables you to set up parameters necessary for a digital output. To enter the option, scroll to the Digital Output entry on the Program Menu and press [ENTER]. The screen appears similar to Figure 3-17 below. To step through each parameter, press the [▼] key. While programming, refer to Figure A-14 on page A-14 of Appendix A, *Menu Maps*.

Digital Output

Function

Data Source

Units/Pulse gal

Pulse Width μs

Polarity

Figure 3-17: The Digital Output Window

1. The first prompt enables you to select the output function from five choices:
 - Off
 - Pulse Totalizer
 - Frequency
 - Test Points
 - Gate Input

Entering the Digital Output (cont.)

- a. Press [ENTER] to open the drop-down menu.
- b. Scroll to the desired function.
- c. Press [ENTER] to confirm your selection.

Note: *If you select Off, you will not be able to access any other parameters in this option. If you select Test Points or Gate Input, the program goes at once to Step 4.*

2. The next prompt asks you to select the data source for the digital output. The choices vary with the function. For Pulse Totalizer (shown in Figure 3-17 on the previous page), the available choices include:
 - Forward Totalizer
 - Reverse Totalizer
 - Forward Energy
 - Reverse Energy
 - a. Press [ENTER] to open the data source selection window, shown in Figure 3-16 on page 3-32.
 - b. Scroll to the desired source.
 - c. Press [SEL] to confirm your selection.
 - d. The prompt then moves to a list of unit types. (The available units depend on the selection made at the Data Source prompt.) Scroll to the desired output unit.
 - e. Press [F3] (OK) to confirm your selection.
3. The last set of parameters that appears depends on the selection you made at the Function prompt.

If you selected Pulse Totalizer:

The prompt asks for the units/pulse, the pulse width (in microseconds), and the polarity. (Figure 3-17 on page 3-34 illustrates a Digital Output window configured for the Pulse Totalizer function.) For the Units/Pulse and Pulse Width parameters:

Entering the Digital Output (cont.)

- a. Press [ENTER] to open the text box.
- b. Use the numeric keys to enter the desired value.
- c. Press [ENTER] to confirm your selection.

For Polarity:

- a. Press [ENTER] to open the drop-down menu.
- b. Scroll to the desired polarity, either Low to High or High to Low.
- c. Press [ENTER] to confirm your selection.

If you selected Frequency:

The prompt asks for the minimum and maximum frequencies and the duty cycle percentage. For each parameter:

- a. Press [ENTER] to open the text box.
- b. Use the numeric keys to enter the desired value.
- c. Press [ENTER] to confirm your selection.

If you entered Test Points:

The prompt asks for the window (trigger) type from two choices, transmit and receive. These two windows can be used to trigger an oscilloscope to look at the receive signal output on another channel.

- a. Press [ENTER] to open the drop-down menu.
- b. Scroll to the desired signal.
- c. Press [ENTER] to confirm your selection.

Entering the Digital Output (cont.)

If you entered Gate Input:

Note: *Gate Input is used to synchronize the totalizer with the meter calibration system (discussed on page 3-44). The gate stops and starts the meter totalizer, so that you can compare the totalizer figure with the measured volume of water in the weight tank.*

1. The prompt asks for the gate active.
 - a. Press [ENTER] to open the drop-down menu.
 - b. Scroll to the desired gate active, whether Contact Open or Contact Closed.
 - c. Press [ENTER] to confirm your selection.
2. The second prompt asks for the mode.
 - a. Press [ENTER] to open the drop-down menu.
 - b. Scroll to the desired mode, either Automatic or Manual.
 - c. Press [ENTER] to confirm your selection.

Stopwatch Totalizer

Through the Gate Input option, you can implement the Stopwatch Totalizer function to measure totals manually. To set up the Totalizer function:

1. At the Gate Active prompt, select Contact Open.
2. At the Mode prompt, select Manual, and press [ENTER].
(Selecting Automatic causes the totalizer to run continuously.)

The stopwatch icon (see page 2-11) appears in the system tray. To start or stop the function, press the minus (-) key on the keypad.

You have completed entering parameters in the Digital Output option.

- To confirm the entries and return to Operate mode, press [F3] (OK). The PT878 returns to Operate Mode.
- To leave the window without confirming the entries, press [F2] (Cancel) or the [ESC] key. The PT878 returns to Operate Mode.

Entering User Functions

User functions enable you to program mathematical equations on each measurement. You can also use any parameter in the meter to calculate a different parameter. To enter the User Functions option, scroll to the User Functions entry on the Program Menu and press [ENTER]. The screen appears similar to Figure 3-18 below. To step through each parameter, press the [▼] key. Refer to Figure A-15 on page A-15 of Appendix A, *Menu Maps*.

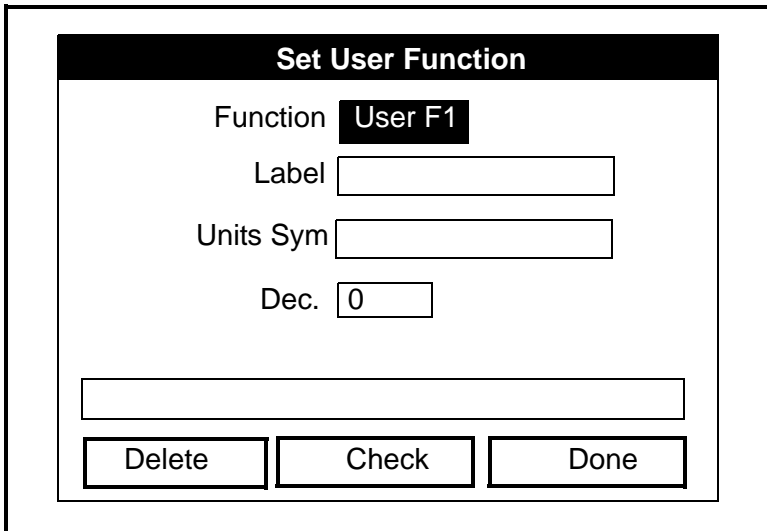

The screenshot shows a window titled "Set User Function". Inside the window, there are several input fields and buttons. The "Function" field is set to "User F1". The "Label" field is empty. The "Units Sym" field is empty. The "Dec." field is set to "0". There is an empty input field below the "Dec." field. At the bottom of the window are three buttons: "Delete", "Check", and "Done".

Figure 3-18: The User Functions Window

1. The first prompt asks you to select the function number, 1 through 8.
 - a. Press [ENTER] to open the drop-down menu.
 - b. Scroll to the desired function number (User F1, User F2, etc.).
 - c. Press [ENTER] to confirm the entry.

Entering User Functions (cont.)

2. The next prompt asks you to create a label for the function. The label corresponds to the measurement type (i.e., velocity or temperature), while the units symbol corresponds to the measurement units (i.e., feet/sec or degrees F).
 - a. Press [ENTER] to open the text creation window, which appears similar to Figure 3-19 below.

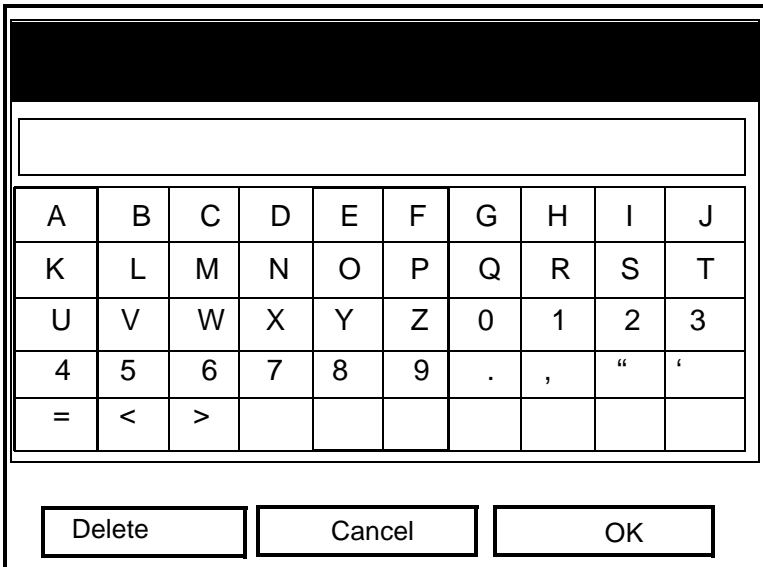

Figure 3-19: The Text Creation Window

- b. Use the four arrow keys to scroll to the desired letter or symbol, and press [ENTER] to add the letter to the label.
- Note:** *Pressing [SEL] causes the screen to alternate between a set of upper-case (capital) letters, a set of lower-case letters, and a set of symbols. Use all three screens to create a desired label.*
- c. Repeat this procedure for each letter or symbol you wish to add to the label. If you wish to delete a letter, press [F1] (Delete) to erase each letter or symbol, from right to left on the label.

Entering User Functions (cont.)

- d. When you have completed the label, press [F3] (OK) to confirm the label, or [F2] (Cancel) to leave the window without adding the label.
3. The next prompt asks for the Units Symbol.
 - a. Press [ENTER] to reopen the text creation window.
 - b. Repeat the procedure used for the Label (on the previous page) to create the Units Symbol.
 - c. When you have completed the label, press [F3] (OK) to confirm the symbol, or [F2] (Cancel) to leave the window without adding the symbol.
4. The next prompt asks you to select the number of decimal places.
 - a. Press [ENTER] to open the drop-down menu.
 - b. Scroll to the desired number of decimal places, ranging from 0 to 4.
 - c. Press [ENTER] to confirm the entry.
5. The final prompt asks for the function itself.
 - a. Press [ENTER] to open the function creation window, which appears similar to Figure 3-20 on the next page.
 - b. Use the four arrow keys to scroll to the desired function or table, and press [ENTER] to confirm each entry. Use the numeric keys to enter numeric values. Press [F1] (Delete) to remove any mistaken or unwanted symbols or numbers.

Note: *Pressing [SEL] causes the screen to alternate between a set of symbols and functions and a list of user functions. Use both screens to create the desired function.*

Entering User Functions (cont.)

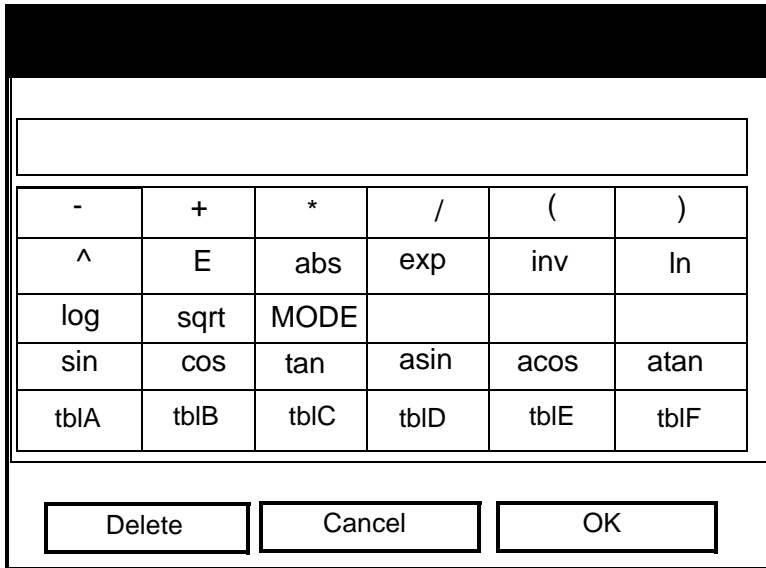

Figure 3-20: The Function Creation Window

- c. To enter a particular measured parameter into the equation, click on the MODE symbol in the middle of the third row. The Select Measurement window (shown in Figure 3-16 on page 3-32) opens. Select the desired data source and unit as discussed on page 3-32, and press [F3] (OK) to confirm the entry.
 - d. When you have completed entering the function, press [F3] (OK) to confirm the entry and return to the User Function window.
6. GE Infrastructure Sensing recommends pressing [F2] (Check) to test the validity of the function. The PT878 displays either "OK" or a message such as "Syntax Error."
 - Press [F1] to delete the entire function, or
 - Press [F3] (Done) to confirm the function and return to Operate Mode.

Entering Correction Factors

The final option in the Program Menu, Correction Factors, allows you to enter and modify three correction factors: Reynolds Correction, Kinematic Viscosity and Calibration Factor. To enter the Correction Factors option, scroll to the Correction Factors entry on the Program Menu and press [ENTER]. The screen appears similar to Figure 3-21 below. To step through each parameter, press the [▼] key. Refer to Figure A-16 on page A-16 of Appendix A, *Menu Maps*.

Correction Factors

Reynolds Correctio Calibration Factor

Re Correction On Off

K/V Factor Single Table

K/V (v) m³/s

Data Source

Figure 3-21: Reynolds Correction Window

Entering Reynolds Correction

The default for Reynolds Correction is “On.” This correction factor should be on in most applications, including all those that utilize clamp-on transducers. It makes a small adjustment to the flow rate reported by the PT878, based on the Kinematic Viscosity. Reynolds Correction is necessary, as the velocity of the fluid measured along a diametrical path must be related to the total area average velocity over the entire pipe cross-section.

Entering Reynolds Correction (cont.)

1. The first prompt asks if you want to enable the Reynolds Correction factor, a number based on the Kinematic Viscosity and flow rate of the fluid.

Note: *If you are using clamp-on transducers, you should enable Reynolds Correction.*

- a. Use the [◀] and [▶] keys to scroll to the appropriate radio button.
- b. Press [ENTER] to confirm your selection.

Note: *If you disable Reynolds Correction, you will not be able to enter any other values in this window.*

2. If you enable Reynolds Correction, you will also need to enter the Kinematic Viscosity of the fluid (available in the brochure *Sound Speeds and Pipe Size Data*, 914-004). The prompt asks for a kinematic viscosity value.
 - a. Press [ENTER] to open the text box.
 - b. Use the numeric keys to enter the desired value (from *Sound Speeds and Pipe Size Data*).
 - c. Press [ENTER] to confirm your selection.

You have completed entering data for a single Kinematic Viscosity factor. Proceed to *Entering a Calibration Factor* on the next page.

- To confirm the entries and return to Operate Mode, press [F3] (OK). The PT878 returns to Operate Mode.
- To leave the window without confirming the entries, press [F2] (Cancel) or the [ESC] key.

Entering a Calibration Factor

The Calibration Factor is used to calibrate or adjust the readings of the PT878 to another flow reference. To enter a Calibration Factor, return to the Reynolds Correction tab at the top of the Correction Factors option. Press the [▶] arrow key to reach the Calibration Factor window. The window appears similar to Figure 3-22 below. To step through each parameter, press the [▼] key.

Figure 3-22: The Calibration Factor Window

1. The first prompt asks if you wish to enable the calibration factor.
 - a. Use the [◀] and [▶] keys to scroll to the appropriate radio button.
 - b. Press [ENTER] to confirm your selection.
2. The next prompt asks if you want a single K factor or a table of K factors.
 - a. Use the [◀] and [▶] keys to scroll to the appropriate radio button.
 - b. Press [ENTER] to confirm your selection.

Entering a Calibration Factor (cont.)

- 3.** The following steps depend on whether you select a single value or a table.

If you entered Single:

The prompt asks for a value. This feature enables a single multiplier to be applied to the flow rate reported by the PT878.

- a.** Press [ENTER] to open the text box.
- b.** Use the numeric keys to enter the desired value. Generally, if you have enabled the Reynolds Correction factor, the correction factor should be set to 1.00. Otherwise, the typical factor is between 0.5 and 2.00.
- c.** Press [ENTER] to confirm your selection.

You have completed entering data for a single Calibration Factor.

- To confirm the entries and return to Operate mode, press [F3] (OK). The PT878 returns to Operate Mode.
- To leave the window without confirming the entries, press [F2] (Cancel) or the [ESC] key. The PT878 returns to Operate Mode.

Entering a Calibration Factor (cont.)

If you entered Table:

The menu asks, first for the data source, and then for the entry of values into the Correction Factor table. This feature allows the user to “curve fit” velocity calibration multiple data points (from several different data sources or flow variables) to the flow rate reported by the PT878.

- a. Press [ENTER] to open the Data Source window.
 - b. Press [F3] (OK) to confirm your selection. (Velocity is the only choice available.)
4. The prompt then asks if you wish to edit the K factor table.
- a. Press [ENTER] to open the table, which appears similar to Figure 3-23 below.

Edit KFactor Table		
<input type="text" value="0"/>		
	Data Source	KFactor
1		
2		
3		
4		
5		

Figure 3-23: The KFactor Table

Entering a Calibration Factor (cont.)

- b.** Use the numeric keys to enter the desired value for the data source, and press [ENTER] to confirm the entry.
- c.** Press the [▶] key to move to the KFactor column. Use the numeric keys to enter the desired value, and press [ENTER] to confirm the entry.
- d.** Repeat steps b and c for the remainder of the table.
- e.** When you have completed entering values, press [F3] (OK) to confirm the table and return to the Correction Factors window.

You have completed entering data for correction factors.

- To confirm the entries and return to Operate mode, press [F3] (OK). The PT878 returns to Operate Mode.
- To leave the window without confirming the entries, press [F2] (Cancel) or the [ESC] key. The PT878 returns to Operate Mode.

Chapter 4

Creating and Managing Sites

As mentioned in Chapter 1, the PT878 can store site data in files for current and future access. (To learn how to program setup data, refer to Chapter 3, *Programming Site Data*.) After you answer the necessary questions, simply save the information to a site file. The Site Manager option then enables you to recall, rename, revert to, print, transfer or delete site files as needed.

To open the Site Menu, press the [MENU] key at the lower right of the PT878 keypad. The Menu Bar replaces the Status Bar at the top of the screen. Then press [ENTER]. The screen now appears similar to Figure 4-1 below. While following the programming instructions, refer to Figures A-1 and A-2 on pages A-1 and A-2 of Appendix A, *Menu Maps*.

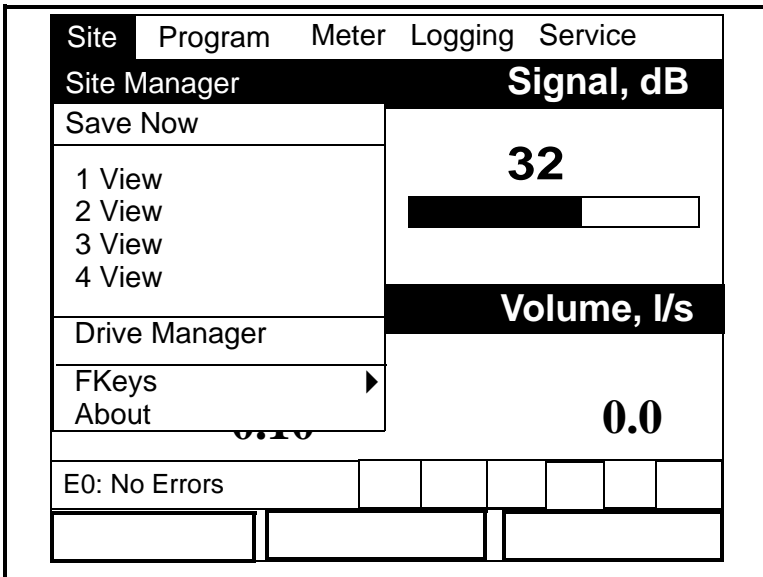

Figure 4-1: The Site Menu

The Site Manager

From the Site Menu, press [ENTER] to open the Site Manager. The screen appears similar to Figure 4-2 below.

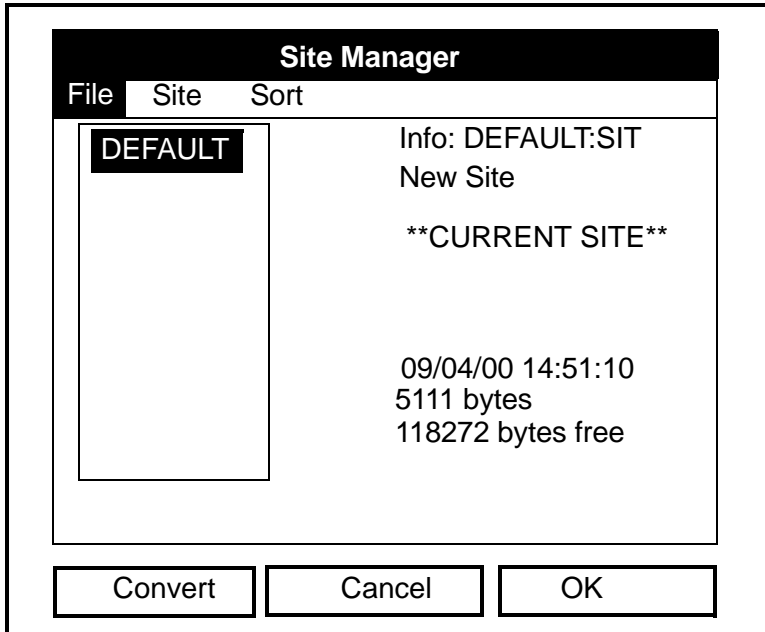

Figure 4-2: The Site Manager Window

Note: *Each PT878 comes preprogrammed with a basic site, Default, which serves as a basis for saving data and creating other sites.*

The right section of the screen supplies information for the site highlighted in the list on the left: its date, time and size, as well as the remaining amount of free memory. You can use the [▼] and [▲] arrow keys to scroll to a particular site and display information pertaining to that site.

To open the Site Manager menu, press [MENU] and then [ENTER]. The screen now appears similar to Figure 4-3 on page 4-3.

The Site Manager (cont.)

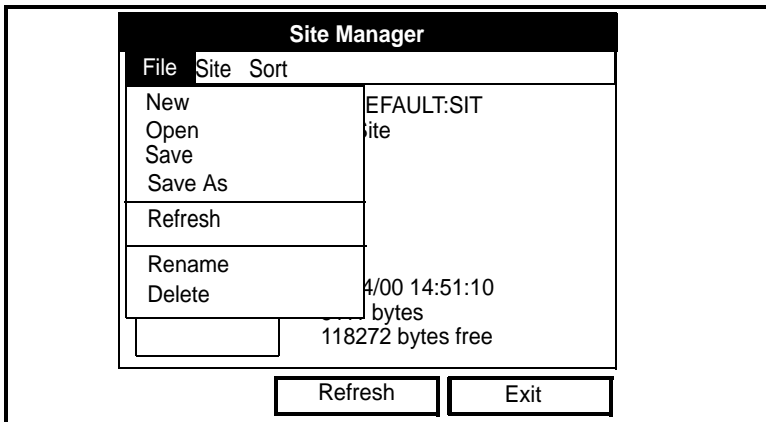

Figure 4-3: The Site Manager Menu

Depending on the choice made above, proceed as follows:

- To create a new site, go to page 4-4.
- To open an existing site (thus replacing the current site), go to page 4-6.
- To save a current site, go to page 4-7.
- To refresh site information, go to page 4-9.
- To rename a site, go to page 4-8.
- To delete a site, go to page 4-10.

You can access five additional functions from the Site submenu (shown in Figure 4-11 on page 4-11).

- To add a site message, go to page 4-11.
- To print out a site, go to page 4-13.
- To transfer a site to a PC, go to page 4-13.
- To transfer a site in text format, go to page 4-14.
- To transfer a site from a PC to the PT878, go to page 4-15.

You can arrange files from the Sort submenu (shown in Figure 4-18 on page 4-18)

- To sort files by name, go to page 4-18.
- To sort files by date, go to page 4-18.

Creating a New Site

Note: *Be sure you have entered the necessary setup data discussed in Chapter 3, Programming Site Data, before creating and saving a new site.*

To create a new site within the Site Manager, press [MENU] to open the File Menu. Be sure the option New is highlighted, and then press [ENTER]. The screen appears similar to Figure 4-4 below.

New Site							
Site 01							
A	B	C	D	E	F	G	H
I	J	K	L	M	N	O	P
Q	R	S	T	U	V	W	X
Y	Z	0	1	2	3	4	5
6	7	8	9	-	_	@	#
&	()						
Delete		Cancel			OK		

Figure 4-4: Name Entry Window for a New Site

1. Use the four arrow keys to scroll to the desired letter or number, and press [ENTER].
2. Repeat this procedure until you have created the desired site name of up to eight characters. (Press [F1], Delete, to remove any unwanted letters or numbers.)
3. When you have finished, press [F3], OK, to confirm the entry, or [F2], Cancel, to leave the window without creating a site.

A second screen appears (as shown in Figure 4-5 on the next page) asking if you want to use the currently highlighted site as a template, with the current display windows, measurements and programmed data. (To modify the display and measurements, refer to Chapter 5, *Displaying and Configuring Data*. To alter programming data, see Chapter 3, *Programming Site Data*.)

Creating a New Site (cont.)

- Press [F2] (No) if you do not want to use it, or
- Press [F3] (Yes) if you do want to use it as a template.

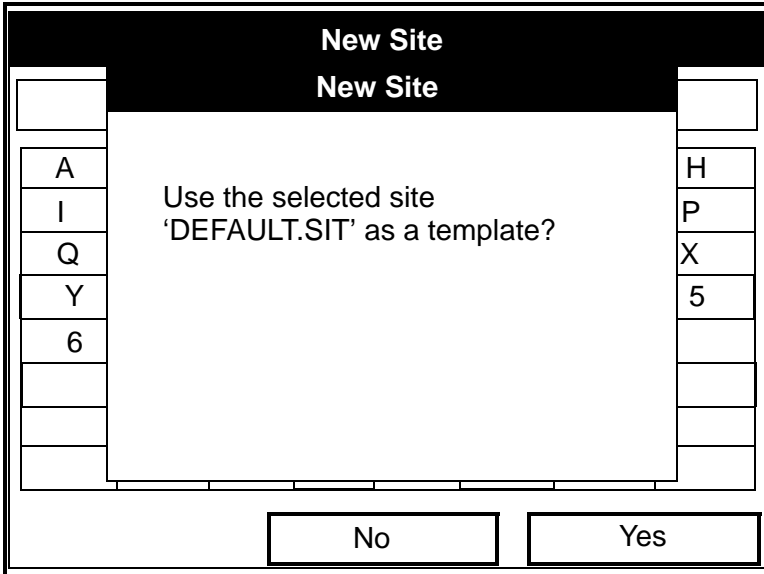

Figure 4-5: Template Confirmation Window

The meter returns to Operate Mode, with the new site name displayed in the upper left corner of the screen.

Opening an Existing Site

If you want to return to a site you have previously saved, first highlight the replacement site in the left window of the Site Manager. Then press [MENU] to open the File Menu. Scroll to the Open option, and press [ENTER]. The screen appears similar to Figure 4-6 below.

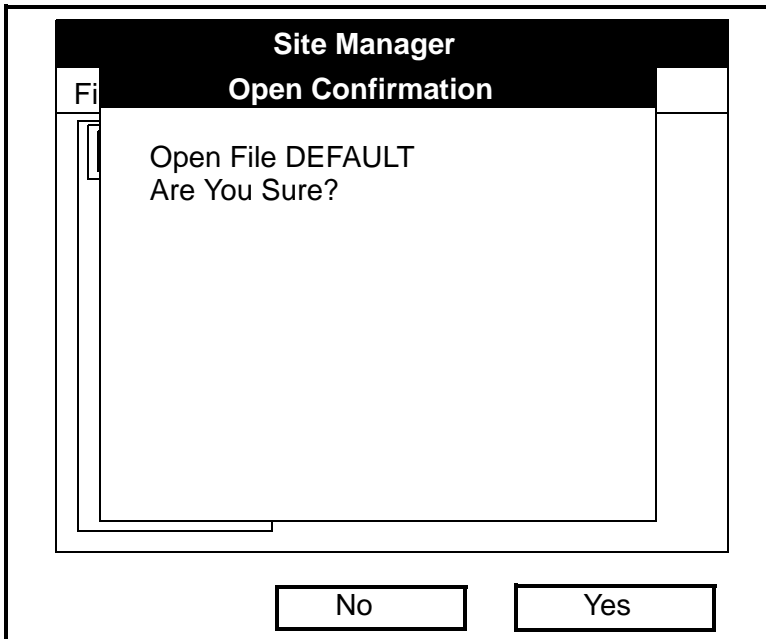

Figure 4-6: The Open Site Confirmation Window

- Press [F2] (No) to cancel opening the site and return to the current site, or
- Press [F3] (Yes) to open the site.

If you have changed the current site, the PT878 asks if you want to save the changes to the previously opened site.

- Press [F2] (No) to cancel the changes, or
- Press [F3] (Yes) to confirm and save the changes.

The PT878 returns to Operate Mode, with the selected site displayed in the upper left corner of the screen.

Saving a Site

You can save the current site in one of two ways:

- From the Site Menu, you can scroll down to the Save Now option and press [ENTER], or
- From within the Site Manager, press [MENU] to open the File Menu, scroll to the Save option, and press [ENTER].

In either case, the screen appears similar to Figure 4-7 below.

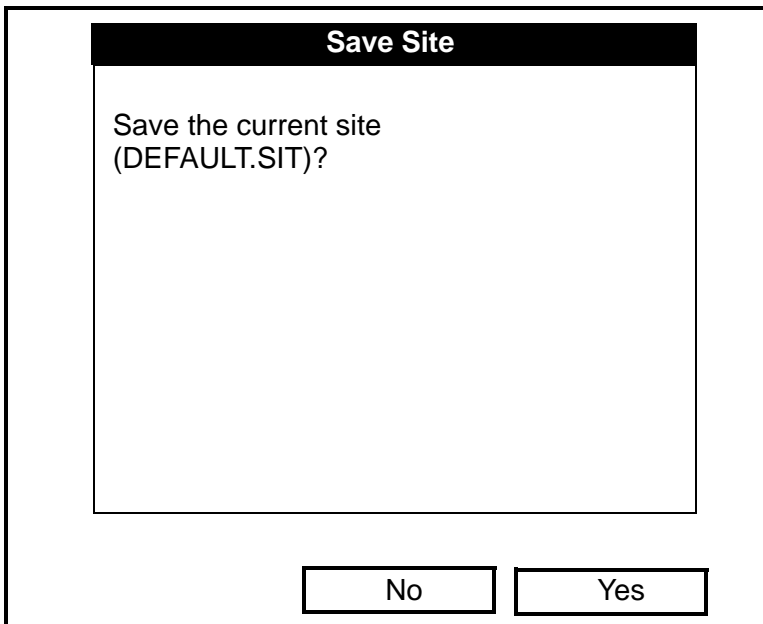

Figure 4-7: The Save Current Site Window

- Press [F2] (No) to cancel saving the site, or
- Press [F3] (Yes) to save the site.

The PT878 remains in the current window (Operate Mode or Site Manager), with the current site saved.

Saving a Site with a Different Name

If you want to save the current site with a different name, open the Site Manager, press [MENU] to open the File Menu, scroll to the Save As option, and press [ENTER]. The screen appears similar to Figure 4-8 below.

Save Current Site

A	B	C	D	E	F	G	H
I	J	K	L	M	N	O	P
Q	R	S	T	U	V	W	X
Y	Z	0	1	2	3	4	5
6	7	8	9				

Delete

Cancel

OK

Figure 4-8: The Save As (Another Name) Window

Use the four arrow keys to scroll to the desired letter or number, and press [ENTER]. Repeat this procedure until you have created the desired site name. (Press [F1], Delete, to remove any unwanted letters or numbers.) When you have finished,

- Press [F2] (Cancel) to erase the entry, or
- Press [F3], OK, to confirm the entry.

The Save Site window then appears.

- Press [F2] (No) to cancel saving the site, or
- Press [F3] (Yes) to save the site.

The PT878 remains in Site Manager, with the current site saved under both the old and new names.

Refreshing a Site

You can refresh a site (updating the display with the most current information) in one of two ways:

- Press [F2], Refresh, to refresh the highlighted file.
- From the File Menu, scroll to the Refresh option and press [ENTER].

The updated information on the highlighted file appears in the window on the right. However, to save the file, you must use the Save option.

Renaming a Site

If you want to rename a site, first be sure the site has been highlighted in the left window of the Site Manager. Then press [MENU] to enter the File Menu, scroll to the Rename option, and press [ENTER]. The screen appears similar to Figure 4-9 below.

Rename Site							
DEFAULT							
A	B	C	D	E	F	G	H
I	J	K	L	M	N	O	P
Q	R	S	T	U	V	W	X
Y	Z	0	1	2	3	4	5
6	7	8	9				
Delete		Cancel			OK		

Figure 4-9: The Rename Site Window

Use the four arrow keys to scroll to the desired letter or number, and press [ENTER]. Repeat this procedure until you have created the desired site name. (Press [F1], Delete, to remove any unwanted letters or numbers.) When you have finished,

- Press [F2] (Cancel) to erase the entry, or
- Press [F3], OK, to confirm the entry.

The PT878 remains in Site Manager, with the site listed under the new name.

Deleting a Site

To delete a site in the Site Manager, first be sure you have highlighted that site in the left window of the Site Manager. Then press [MENU] to open the File Menu, scroll to the Delete option, and press [ENTER]. The screen appears similar to Figure 4-10 below.

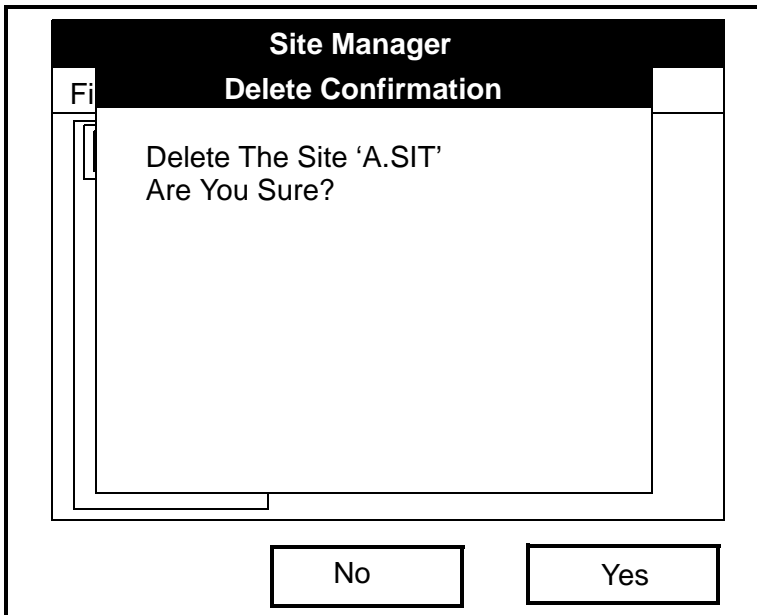

Figure 4-10: The Delete Confirmation Window

- Press [F2], No, to cancel the deletion and return to the Site Manager, or
- Press [F3], Yes, to delete the site.

The Site Manager appears, with the highlighted site now deleted.

Creating a Site Message

The Site Message option allows you to add an explanatory message (with up to 30 characters or spaces) for any given site. To create a site message:

1. Press [MENU] to enter the File Menu. Then press the [▶] arrow key once to scroll from the File Menu to the Site Menu. Press [ENTER]. The screen appears similar to Figure 4-11 below.

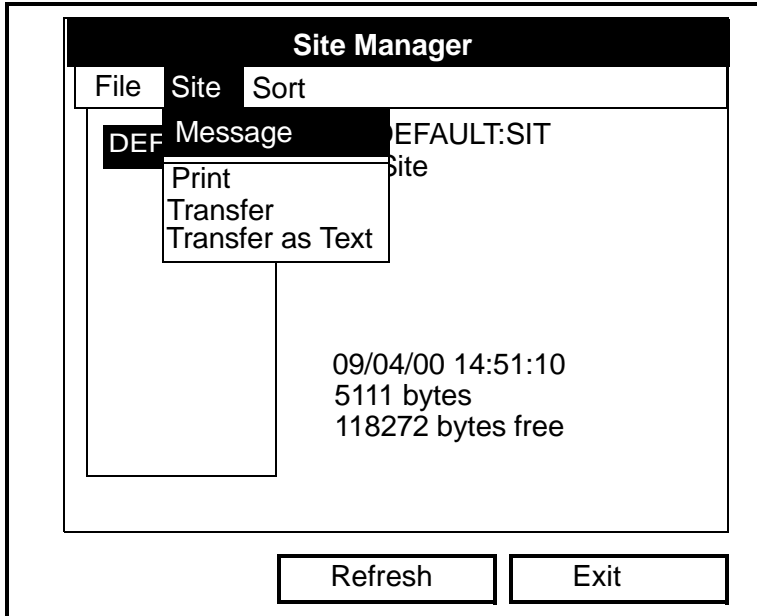

Figure 4-11: The Site Menu in the Site Manager

2. Press [ENTER] to select “Message,” which opens the text creation window, shown in Figure 4-12 on the next page.

Creating a Site Message (cont.)

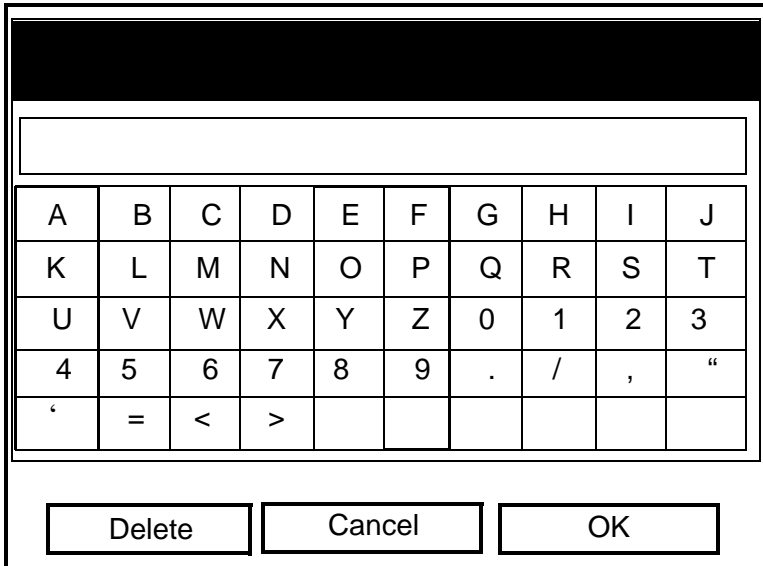

Figure 4-12: The Text Creation Window

- Use the four arrow keys to scroll to the desired letter or symbol, and press [ENTER] to add the letter to the message.

Note: *Pressing [SEL] causes the screen to alternate between a set of upper-case (capital) letters, a set of lower-case letters, and a set of symbols. Use all three screens to create a desired message.*

- Repeat this procedure for each letter or symbol you wish to add to the message. If you wish to delete a letter, press [F1] (Delete) to erase each letter or symbol, from right to left on the label.

When you have completed the message, press [F3] (OK) to confirm the message, or [F2] (Cancel) to leave the window without adding the message.

Printing a Current Site

To print the current site from within the Site Manager, press [MENU] to open the File Menu. Then press the [▶] arrow key once to scroll from the File Menu to the Site Menu. Scroll to the Print option, and press [ENTER]. The PT878 shows a message indicating that its infrared sensor is looking for a receiving printer. (If the sensor spots no printer, a window appears indicating that it cannot find a device. If it spots more than one compatible infrared device within its range, it asks you to select the desired device.) If successful, the Site Manager window appears.

- Press [F2] (No) to cancel printing, or
- Press [F3] (Yes) to print the current site.

The PT878 returns to Operate Mode, while the printer prints out the current site.

Transferring a Site File to a PC

To upload a site file to a PC, you must have an infrared sensor connected to the PC that can receive data from the PT878 IR beam.

1. Check that the Communications option on the PT878 (see page 6-16) has been set to the IrDA protocol, and that the IR beam on the PT878 has clear access to the IR sensor connected to the PC port.

Note: *For Windows NT 4.0, check that the QuickBeam[®] software (available through the path C:\Program Files\QuickBeam Suite) is running.*

2. Highlight the desired site in the left window of the Site Manager.
3. Press [MENU] to open the File Menu. Then press the [▶] arrow key once to scroll from the File Menu to the Site Menu. Scroll to the Transfer option, and press [ENTER].

Transferring a Site to a PC (cont.)

The screen shows a message indicating that the PT878 is searching for an infrared device. (If the PT878 cannot detect an infrared device, a window appears indicating this problem, and asks if you want to try again.) If it finds a device, it sends another message indicating that it is uploading the site. (The meter also displays a message if the upload fails.) When the upload is complete, the meter returns to the Site Manager. The PC holds the transferred file in the QuickBeam Inbox folder (for Windows NT 4.0), as shown in Figure 4-13 below. If you are using other Windows operating systems, the transferred file appears in *C:\My Received Files*. You can open the file on the PC using any text editor.



Figure 4-13: The IR_Inbox Folder with Transferred Site File

Transferring a Site File in Text Format to a PC

To transfer a site file in text format from the PT878 to a PC, be sure the PC is equipped with an infrared sensor as discussed on the previous page.

1. Highlight the desired site in the left window of the Site Manager.
2. Press [MENU] to open the File Menu. Then press the [▶] arrow key once to scroll from the File Menu to the Site Menu. Scroll to the Transfer as Text option, and press [ENTER].

The PT878 uploads the file in the same manner as a site file, but with a .prt suffix. You can then open the file on the PC using any text editor.

Transferring a File from a PC to the PT878

Once you have stored site or meter files to a PC, you can then transfer them back to the PT878 over an IR sensor (connected to the PC) through the PT878 IR interface. The PT878 only accepts files with a .sit (site) or .met (meter) extension. If you rename another type of file with one of these extensions and transfer it, it will be transferred, but will not function if you open it. Also, if you are transferring a file and the meter already has a file with the identical name, the meter will overwrite its current file with the transferred file. If the transferred file has a name longer than eight characters, the meter will shorten the name to eight characters, and replace any spaces in the name with underbars.

To download a site or meter file from a PC to a PT878:

1. Check that the Communications option on the PT878 (see page 6-16) has been set to the IrDA protocol, and that the IR beam on the PT878 has clear access to the IR sensor connected to the PC port.

Note: *For Windows NT 4.0, check that the QuickBeam[®] software (available through the path C:\Program Files\QuickBeam Suite) is running.*

2. You can send the file in one of two ways.

For Windows NT 4.0:

- Click on the desired file, and drag it onto the rocket button in the QuickBeam window, as shown in Figure 4-14 below, or:

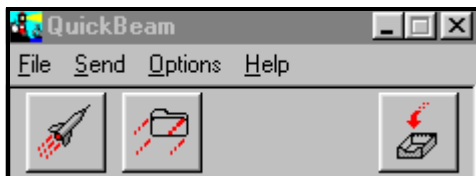

Figure 4-14: The QuickBeam Window

Transferring a File from a PC to the PT878 (cont.)

- Open the Send menu in the QuickBeam window, enter the *Files* or *Files on Clipboard* option, scroll to the desired file, and click *Send*. QuickBeam opens a window indicating that it is downloading the file. If you close and reopen the Site Manager, the file appears as one of the listed sites.

For Windows 95/98/2000:

- Click on the *Infrared* icon in the System Tray of your PC, as shown in Figure 4-15 below.



Figure 4-15:
Infrared Icon in System Tray

The *Wireless Link* window (for Windows 2000, shown in Figure 4-16 below) or the *Infrared Transfer Application* (for Windows 95/98) appears. Select the desired file, and click *Send*, or

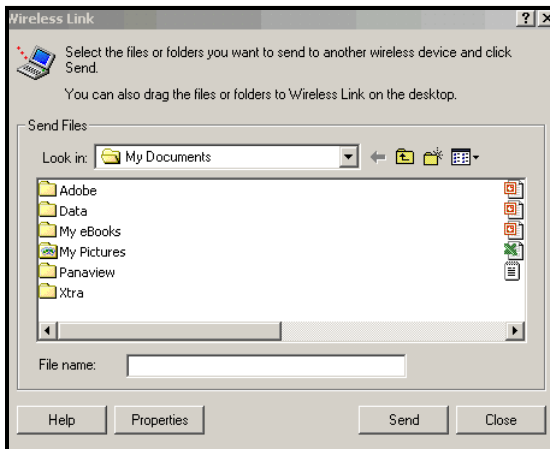

Figure 4-16: *Wireless Link* Window

Transferring a File from a PC to the PT878 (cont.)

- From *Windows Explorer*, right-click on the selected file. Select *Send To* → *Infrared Recipient* or *Nearby Computer*. For Windows 2000, you can also drag the selected file to the *Wireless Link* icon, shown in Figure 4-17 below.



Figure 4-17: The Wireless Link Icon

Note: *While sending or receiving files, the PT878 continues to perform measurements, but at a slower rate than normal.*

Listing Files by Name

If you want to list your files alphabetically by site name within the Site Manager, press [MENU] to open the File Menu. Then press the [▶] arrow key twice to scroll from the File Menu to the Sort Menu, shown in Figure 4-18 below. Press [ENTER]. The Site Manager screen refreshes, with the sites listed in alphabetical order.

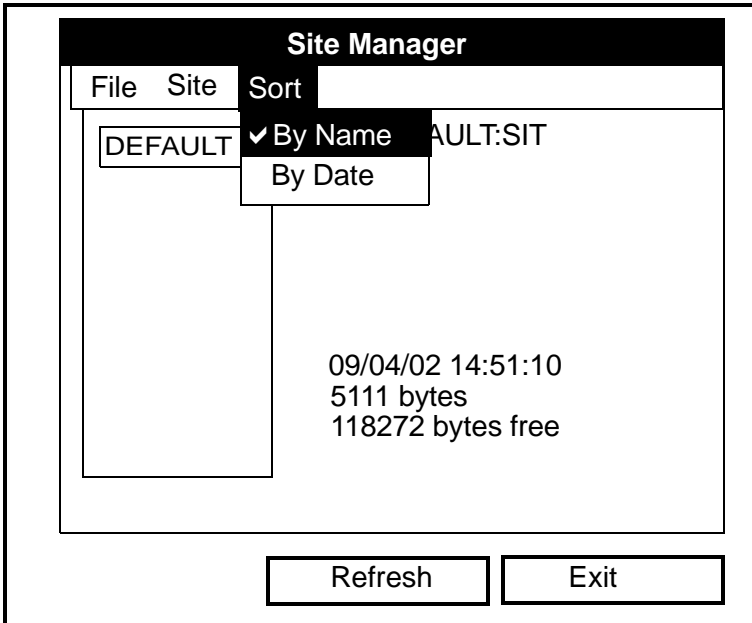

Figure 4-18: The Sort Submenu

Listing Files in Chronological Order

If you prefer to list your files chronologically by time of creation within the Site Manager, press [MENU] to open the File Menu. Then press the [▶] arrow key twice to scroll from the File Menu to the Sort Menu, and scroll to the By Date option. Press [ENTER]. The Site Manager screen refreshes, with the sites listed in chronological order, from the most recent to the earliest.

Chapter 5

Displaying and Configuring Data

The PT878 allows you to view from one to four different measurement parameters simultaneously. The screen can show these parameters not only in numeric format, but as line or bar graphs as well.

You can configure any given measurement for your particular requirements. To configure an individual measurement, press [SEL] from the Operate Mode window shown in Figure 2-4 on page 2-8. A cursor appears next to the parameter closest to the upper left corner. Continuing to press [SEL] enables the cursor to scroll through the other displayed measurements. Once you have reached a particular window, pressing the [ENTER] button opens the menu for that window, as shown in Figure 5-1 below. To learn how to use the display window menu, go to pages 5-2 to 5-6.

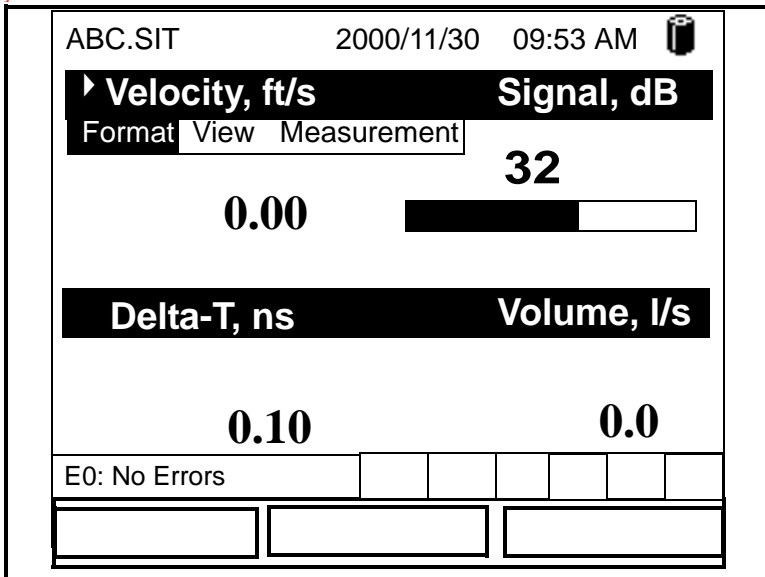
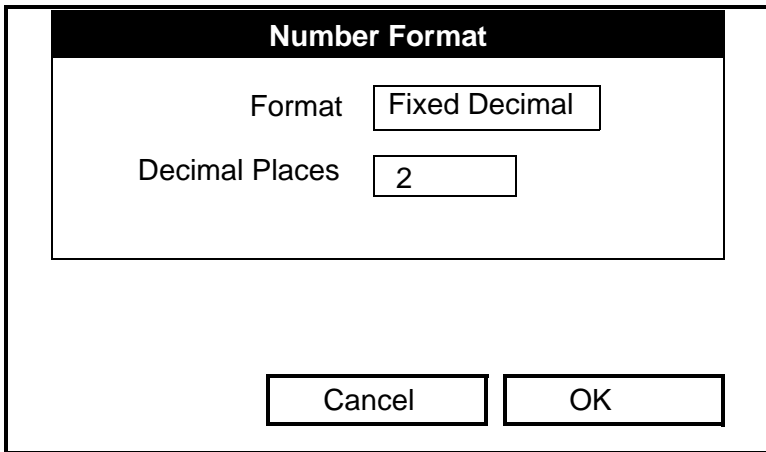

Figure 5-1: Display Screen After Pressing [SEL]

The Format Option

The first option on the menu, Format, allows you to specify the type of notation and the number of decimal places for the measurement in that window. Press [ENTER] and the submenu shows two options, Decimal Place and Notation. Press the [▼] or [▲] arrow keys to select either entry, and press [ENTER]. The screen appears similar to Figure 5-2 below. To scroll to a particular parameter or menu entry, press the [▼] or [▲] key.

Note: *If the window displays a line or bar graph, the Limits option appears instead of Format in the menu.*



The image shows a window titled "Number Format". Inside the window, there are two input fields. The first is labeled "Format" and contains the text "Fixed Decimal". The second is labeled "Decimal Places" and contains the number "2". Below these fields are two buttons: "Cancel" and "OK".

Figure 5-2: The Number Format Window

1. The first entry, Format, asks you to select the numeric format from three choices: default, fixed decimal and scientific. Default provides the default resolution, while Fixed Decimal allows users to override the standard resolution. Scientific format displays the value in mantissa and exponent format.
 - a. Press [ENTER] to open the drop-down list of format choices.
 - b. Scroll to the appropriate selection.
 - c. Press [ENTER] to confirm your choice.

The Format Option (cont.)

2. The second step asks you to choose the number of decimal places to be displayed. Available choices range from 0 to 4 places.
 - a. Press [ENTER] to open the drop-down list.
 - b. Scroll to the appropriate number.
 - c. Press [ENTER] to confirm your choice.
- To confirm the entries and return to Operate mode, press [F3] (OK).
- To leave the window without confirming the entries, press [F2] (Cancel) or the [ESC] key.

The View Option

The second option, View, allows you to select the presentation of a parameter in one of three formats: numeric, line graph or bar graph.

1. From the Display Menu, press the [▶] key once to reach the View option, and then press [ENTER].
2. A drop-down menu shows the three formats. Scroll to the appropriate selection.
3. Press [ENTER] to confirm your selection.

The screen immediately displays any changes. For example, if you have changed the first parameter to a line graph, the screen appears similar to Figure 5-3 below.

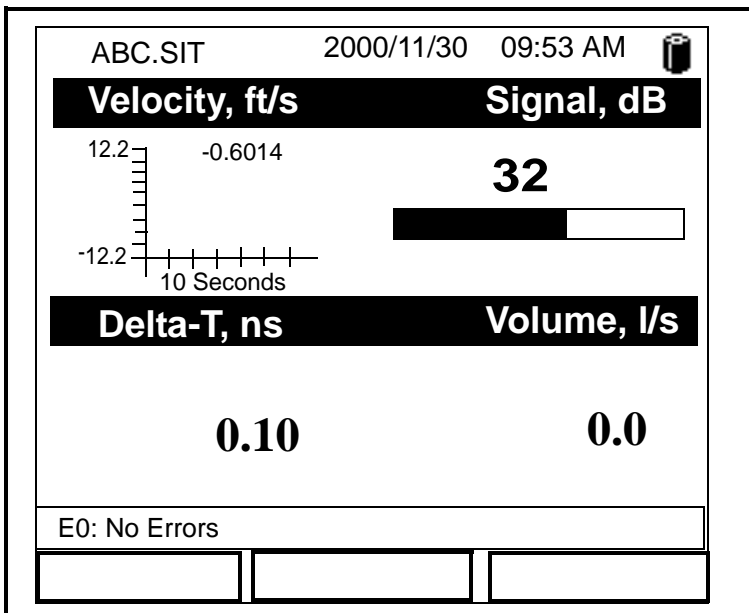

Figure 5-3: Screen After Format Change

The Limits Option

Once you have configured a parameter as a line or bar graph, you might need to change its presentation or values. The Limits option (replacing the Format option for line and bar graphs) enables you to program the minimum or maximum values displayed, the time interval and the display of the average value.

To enter the Limits option:

1. Press [SEL] from the Operate Mode window until you have reached the desired measurement.
2. Press [ENTER] to open the Display Menu.
3. Be sure the Limits option is highlighted, and press [ENTER].
4. A drop-down menu entry, Change, appears. Press [ENTER] again.

The screen appears similar to Figure 5-4 below.

Set Line Graph Parameters

Velocity

Minimum

Maximum

Use Lines

Plot Average Value

Show Minimum and Maximum

Figure 5-4: The Line (or Bar) Graph Parameters Window

The Limits Option (cont.)

5. The first prompt asks for the minimum value shown in the graph.
 - a. Press [ENTER] to open the text box.
 - b. Use the numeric keys to enter the desired value.
 - c. Press [ENTER] to confirm the value.
6. Repeat the procedure in step 5 to enter the maximum value.

A line graph involves two more prompts.

7. The next prompt asks for the display interval.
 - a. Press [ENTER] to open the text box. Use the numeric keys to enter the desired number. Press [ENTER] to confirm the value.
 - b. The second box asks for the interval in terms of seconds, minutes, hours, or days. Press [ENTER] to open the drop-down menu, and then press the [▼] or [▲] keys to move to the desired parameter. Press [ENTER] to confirm the entry.
8. The final three prompts ask for details of the graph configuration: if you want to use lines, plot the average value, or show the minimum and maximum values. Press the [▼] key to step through each value, and press [ENTER] to add a given detail as part of the graph.
9. When you have configured the graph, press [F3], OK, to confirm the graph settings.

The screen returns to Operate Mode, and displays any changes.

The Measurement Option

On occasion, you might need to change the actual parameter measured in a given window. The Measurement option enables you to reconfigure the window with one of five categories of data source (velocity, volume, forward or reverse totalizer, power, energy or diagnostics) and appropriate English or metric measurement units.

To enter the Measurement option:

1. Press [SEL] from the Operate Mode window until you have reached the desired measurement.
2. Press [ENTER] to open the Display Menu.
3. Be sure the Measurement option is highlighted, and press [ENTER].
4. A drop-down menu entry, Change, appears. Press [ENTER] again.

The screen appears similar to Figure 5-5 on the next page. The left column displays the five measurement data sources, while the right column displays English and metric measurement units (or, with the Diagnostics source shown, a list of diagnostics parameters).

5. Use the [▼] and [▲] arrow keys to reach the desired data source, and press [SEL].
6. Then use the [▼] or [▲] arrow keys to select the desired measurement unit (or diagnostic parameter). Press [F3], OK, to confirm the entry.
7. The screen returns to Operate Mode, and displays any changes.

The Measurement Option (cont.)

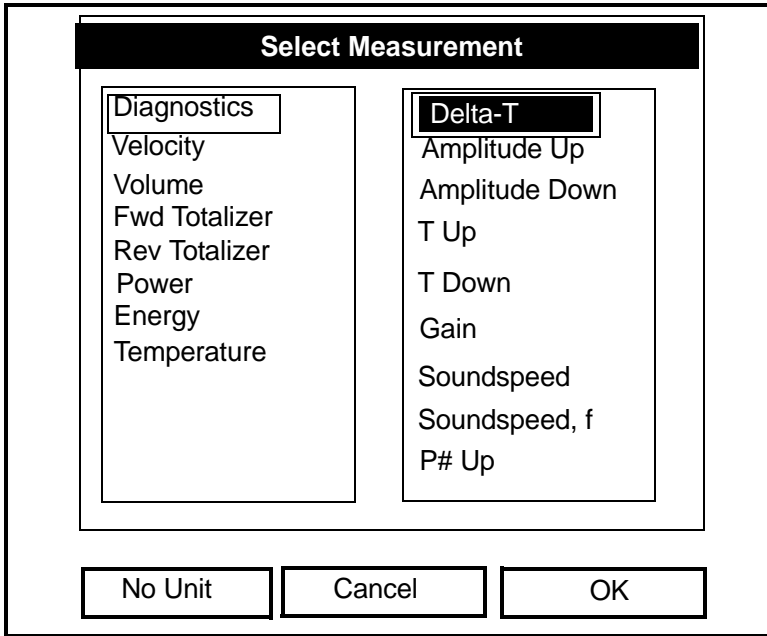

Figure 5-5: The Measurement Menu Window

Customizing the Display Screen

You might wish to display one or two parameters, or customize the soft keys to quickly access particular menus. The Site Menu enables you to make more comprehensive changes in your display screen.

To enter the Site Menu, press the [MENU] key at the lower right of the PT878 keypad. The Menu Bar replaces the Status Bar at the top of the screen. The Site Menu will be highlighted in the upper left corner. Press [ENTER] or the [▼] arrow key. The screen now appears similar to Figure 5-6 below. While following the programming instructions, refer to Figure A-2 on page A-2 of Appendix A, *Menu Maps*.

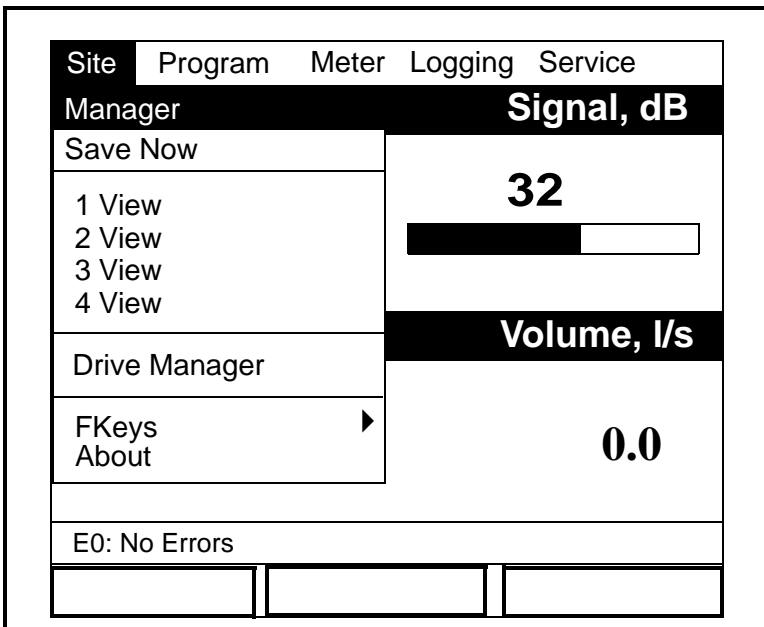

Figure 5-6: The Site Menu

- To specify the number of parameters displayed, go to page 5-10.
- To customize or clear softkeys (FKeys), go to page 5-11.

Specifying the Number of Displayed Parameters

As mentioned earlier, the PT878 can display one to four different measurement parameters simultaneously. However, sometimes you might wish to display only one or two parameters. To change the number of open display windows from within the Site Menu (shown in Figure 5-6 on the previous page), use the [▼] or [▲] arrow keys to move to the desired number of views (1 View, 2 Views, etc.) Press [ENTER].

The screen displays the designated number of windows. For example, Figure 5-7 below shows the screen displayed in Figure 5-3 on page 5-4, reconfigured for a single view.

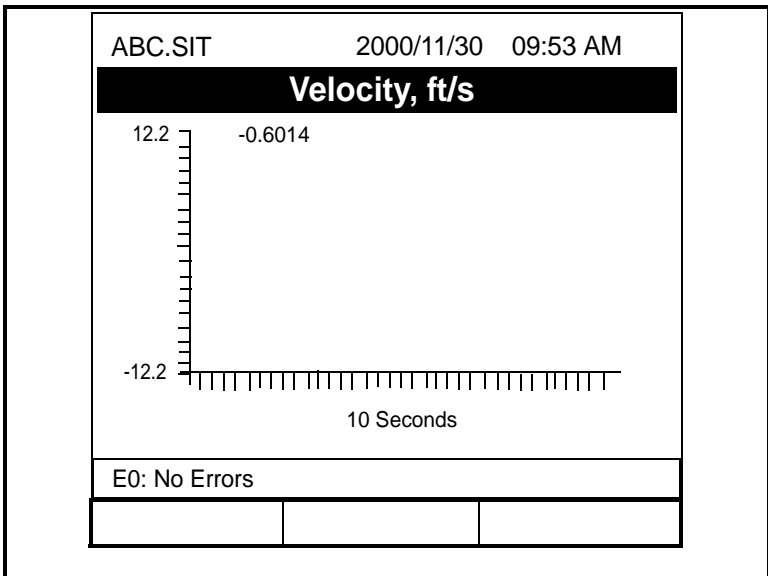

Figure 5-7: Display Screen Configured for Single View

Note: *The PT878 opens display windows clockwise from the upper left; that is, if you press “1 View,” the parameter displayed in the upper left window appears. If you press “2 Views,” the parameters shown in the two top windows appear. The view for “3 Views” adds the window in the lower left, and that for “4 Views” adds the window in the lower right.*

Customizing Softkeys

When the screen is in Operate Mode, you might wish to access a particular submenu frequently without the trouble of scrolling through menus. Customizing the softkeys ([F1], [F2] and [F3]) allows you to access up to three submenus by pressing the associated softkey. You can customize a softkey from the Site Menu or from within a particular menu.

- To customize a softkey from within the Site Menu:
 1. From the Site Menu (shown in Figure 5-6 on page 5-9), use the [▼] or [▲] arrow keys to move to the FKeys entry on the menu. Press [ENTER]. The screen now appears similar to Figure 5-8 below.

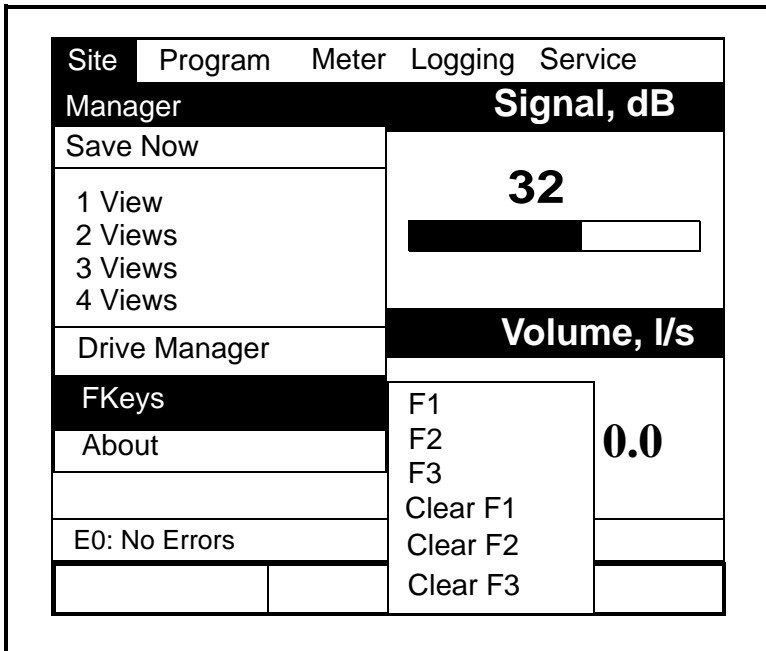

Figure 5-8: The FKeys Menu

2. Use the [▼] or [▲] arrow keys to move to the desired FKey (1, 2 or 3) entry on the menu. Press [ENTER]. The Configure FKey window opens, as shown in Figure 5-9 on the next page.

Customizing Softkeys (cont.)

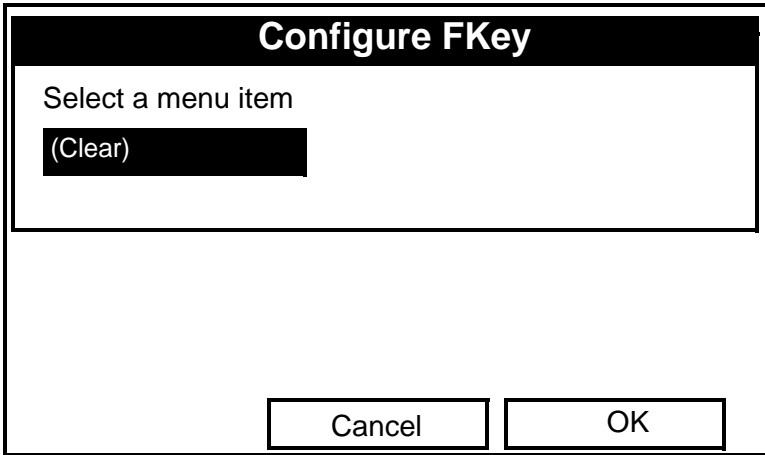

Figure 5-9: The Configure FKey Window

3. Press [ENTER] to open the menu drop-down list. Then use the [▼] or [▲] arrow keys to scroll to the desired submenu (for example, Contrast).
4. Press [ENTER] to confirm the entry, and press [F3] (OK) to confirm the entry and close the window. (Press [F2] (Cancel) to close the window without changing the key.)

The screen now appears similar to Figure 5-10 on page 5-13, with the [F1] window displaying “Contrast.” Pressing [F1] opens the Contrast window.

- To customize a softkey from a particular menu:
 1. Open the desired menu on the Menu Bar (see Chapters 3, 4, 6, 7 and 8 for details on particular menus) and scroll to the desired option.
 2. Press the desired softkey. A window appears with the question, “Assign current menu command to FKeyX?”
 3. Press [F3] (Yes) to confirm the assignment and close the window. (Press [F2] (No) to close the window without changing the key.)

Customizing Softkeys (cont.)

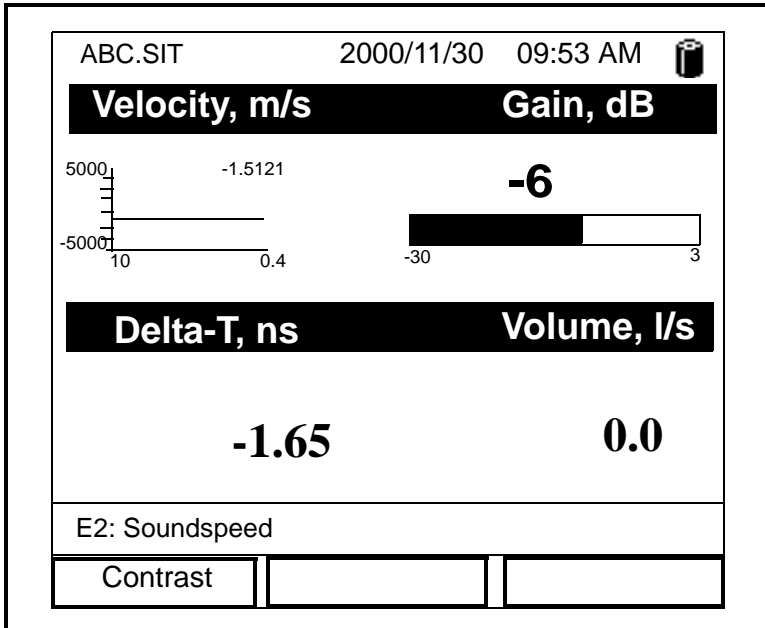

Figure 5-10: The Display Screen with Modified Softkey

- To clear a softkey:
 1. From the Site Menu (shown in Figure 5-6 on page 5-9), use the [▼] or [▲] arrow keys to move to the FKeys entry on the menu. Press [ENTER]. The screen now appears similar to Figure 5-8 on page 5-11.
 2. Use the [▼] or [▲] arrow keys to move to the desired Clear FKey (1, 2 or 3) entry on the menu. Press [ENTER].

The softkey window clears. You can also clear the softkey through the Configure FKey window, by selecting (Clear) as an entry, pressing [ENTER] and then [F3], OK.

Note: *Since the customized softkeys are saved globally, they will remain, even if you change site files.*

Managing Files — The Drive Manager

On occasion, you might want to review, print or transfer some or all of the files in the PT878. The Drive Manager allows you to view all the files stored in the meter. While following the programming instructions, refer to Figure A-2 on page A-2 of Appendix A, *Menu Maps*. To open the Drive Manager:

1. Press [MENU].
2. From the Site Menu (shown in Figure 5-6 on page 5-9), use the [▼] or [▲] arrow keys to move to the Drive Manager entry on the menu. Press [ENTER]. The screen now appears similar to Figure 5-11 below.

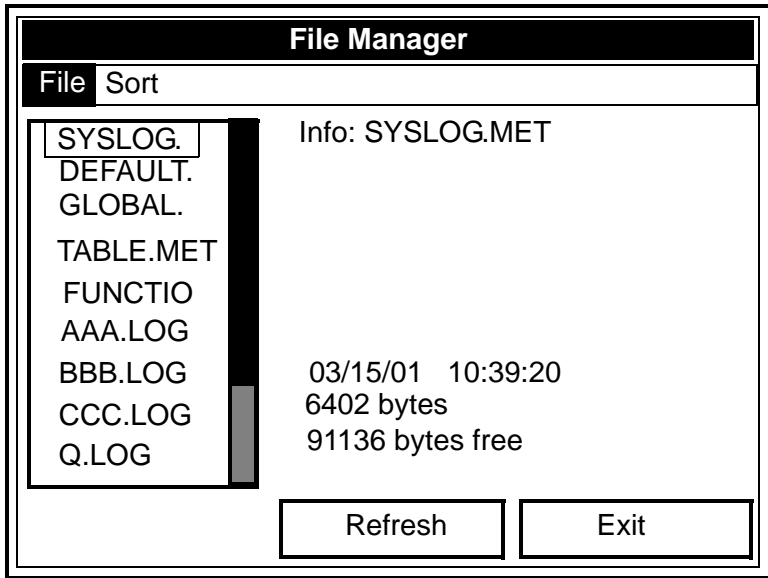

Figure 5-11: The Drive Manager Window

The window on the left lists all the meter, site and log files in the PT878, while the window on the right displays information on the file highlighted in the left window.

Managing Files — The Drive Manager (cont.)

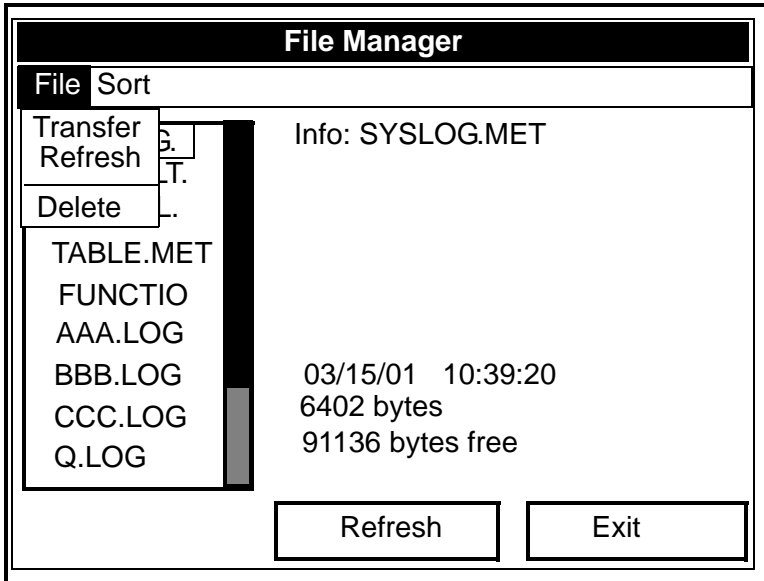

Figure 5-12: The File Manager Menu

To transfer, refresh or delete a file, first be sure the file is highlighted in the window on the left. Then press [MENU] to open the File Menu, and scroll to the appropriate option, as shown in Figure 5-12 above. Press [ENTER]. The PT878 then performs the desired action with the file.

Transferring a File to a PC

To upload a log, meter, bitmap or site file to a PC:

1. Check that the Communications option on the PT878 (see page 6-16) has been set to the IrDA protocol, and that the IR beam on the PT878 has clear access to the IR sensor connected to the PC port.

Note: *For Windows NT4.0, check that the QuickBeam software (available through the path C:\Program Files\QuickBeam Suite) is running.*

2. Highlight the desired site in the left window of the Drive Manager.
3. Press [MENU], scroll to the Transfer option, and press [ENTER].

The screen shows a message indicating that the PT878 is searching for an infrared device. (If the scanner spots no device, a window appears with this message, and asks if you want to try again.) If it finds a device, it sends another message indicating that it is uploading the site. (The meter also displays a message if the upload fails.) When the upload is complete, the meter returns to the Drive Manager. The PC holds the transferred file in the C:\IR_Inbox folder (C:\My Received Files for Windows 98, or Desktop for Windows 2000), as shown in Figure 5-13 below. You can open the file on the PC using any text editor.

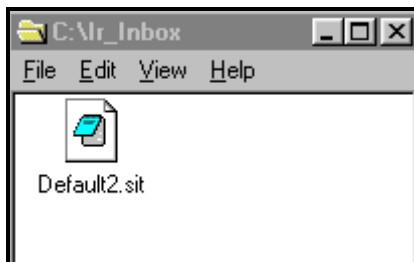

Figure 5-13: The IR_Inbox Folder with Transferred File

Transferring a File from a PC to the PT878

Once you have stored site or meter files to a PC, you can then transfer them back to the PT878 over the IR interface. The PT878 only accepts files with a .sit (site) or .met (meter) extension. If you try renaming another type of file with a .sit or .met extension and transfer it, it will be transferred, but it will not function if you open it. Also, if you are transferring a file and the meter already has a file with the identical name, the meter will overwrite its current file with the transferred file. If the transferred file has a name longer than eight characters, the meter will shorten the name to eight characters, and replace any spaces in the name with underbars.

Note: *It is not possible to download log files back to the PT878.*

To download a site or meter file from a PC to a PT878:

1. Check that the Communications option on the PT878 (see page 6-16) has been set to the IrDA protocol, and that the IR beam on the PT878 has clear access to the IR sensor connected to the PC port.

Note: *For Windows NT4.0, check that the QuickBeam software (available through the path C:\Program Files\QuickBeam Suite) is running.*

2. You can send the file in one of two ways.

For Windows NT 4.0:

- Click on the desired file, and drag it onto the rocket button in the QuickBeam window, as shown in Figure 5-14 below, or

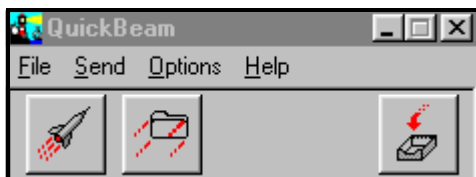

Figure 5-14: The QuickBeam Window

Transferring a File from a PC to the PT878 (cont.)

- Open the Send menu in the QuickBeam window, enter the *Files* or *Files on Clipboard* option, scroll to the desired file, and click *Send*.

QuickBeam opens a window indicating that it is downloading the file. When the download is complete, the meter returns to the Drive Manager. If you close and reopen the Drive Manager, the file appears as one of the listed sites.

For Windows 95/98/2000:

- Click on the *Infrared* icon in the System Tray of your PC, as shown in Figure 5-15 below.



Figure 5-15:
Infrared Icon in System Tray

The *Wireless Link* window (for Windows 2000, shown in Figure 5-16 below) or the *Infrared Transfer Application* (for Windows 95/98) appears. Select the desired file, and click *Send*, or

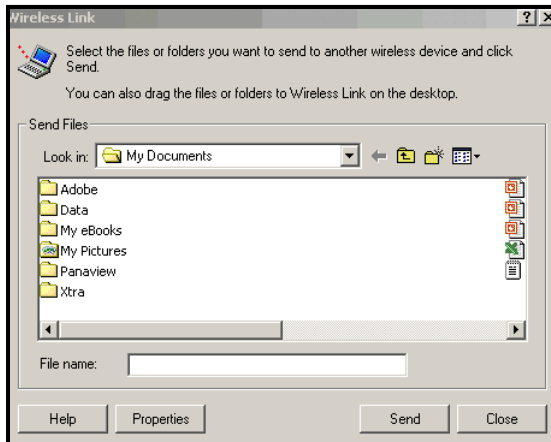

Figure 5-16: Wireless Link Window

Transferring a File from a PC to the PT878 (cont.)

- From *Windows Explorer*, right-click on the selected file. Select *Send To* → *Infrared Recipient* or *Nearby Computer*. In Windows 2000, you can also drag the selected file to the *Wireless Link* icon, shown in Figure 5-17 below.



Figure 5-17: The Wireless Link Icon

Note: *While sending or receiving files, the PT878 continues to perform measurements, but at a slower rate than normal.*

Refreshing a File

To refresh a file so that the PT878 displays the most recent information, you have two options:

- Press [MENU], scroll to the Refresh option, and press [ENTER].
- Press [F2] (Refresh).

In either case, the window on the right of the File Manager displays the most recent file information.

Deleting a File

To delete a file in the File Manager, first be sure you have highlighted that file in the left window of the File Manager. Then press [MENU], scroll to the Delete option, and press [ENTER]. The screen appears similar to Figure 5-18 on the next page.

Deleting a File (cont.)

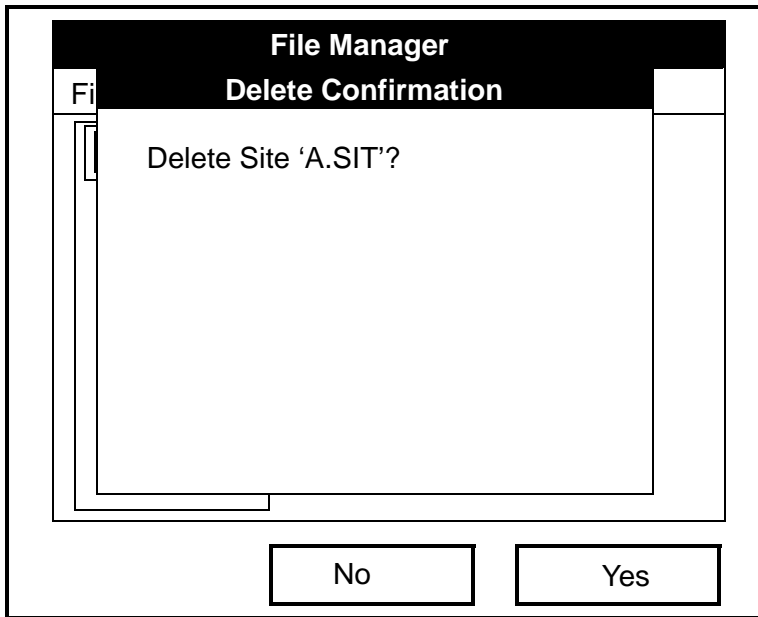

Figure 5-18: The Delete Confirmation Window

- Press [F2], No, to cancel the deletion and return to the File Manager, or
- Press [F3], Yes, to delete the site.

The File Manager appears, with the highlighted site now deleted.

Listing Files by Name

If you want to list your files alphabetically by site name within the File Manager, press [MENU] to open the File Menu. Then press the [▶] arrow key to scroll from the File Menu to the Sort Menu, shown in Figure 5-19 on the next page. Press [ENTER]. The File Manager screen refreshes, with the sites listed in alphabetical order.

Listing Files by Name (cont.)

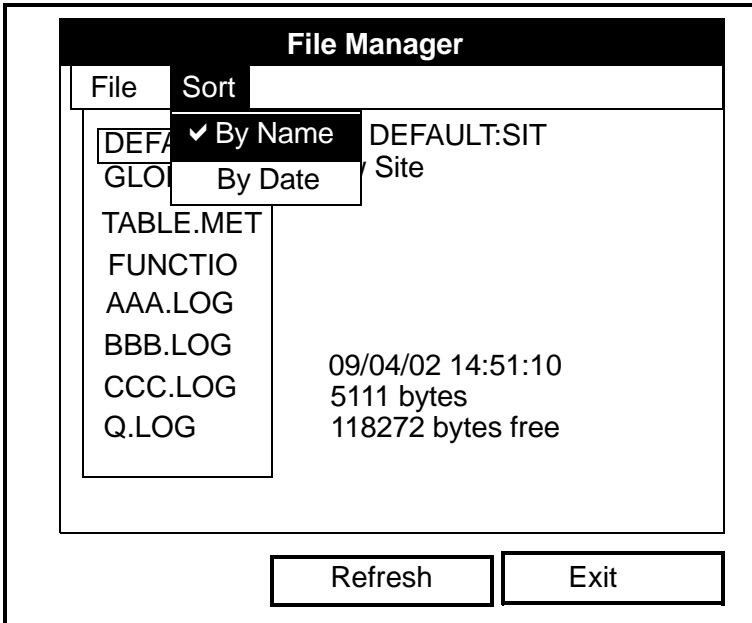

Figure 5-19: The Sort Submenu

Listing Files in Chronological Order

If you prefer to list your files chronologically by time of creation within the File Manager, press [MENU] to open the File Menu. Then press the [▶] arrow key to scroll from the File Menu to the Sort Menu, and scroll to the By Date option. Press [ENTER]. The Site Manager screen refreshes, with the sites listed in chronological order, from the most recent to the earliest.

Accessing Meter Data –The About Option

The About option displays useful information concerning the model number and software version of any given PT878. While the window normally appears briefly at startup, users might want to access the information for a longer period. To open the About window, scroll to the About option on the Site Menu and press [ENTER]. The screen appears similar to Figure 5-20 below. To access data on your specific PT878, press [F2] (Next).

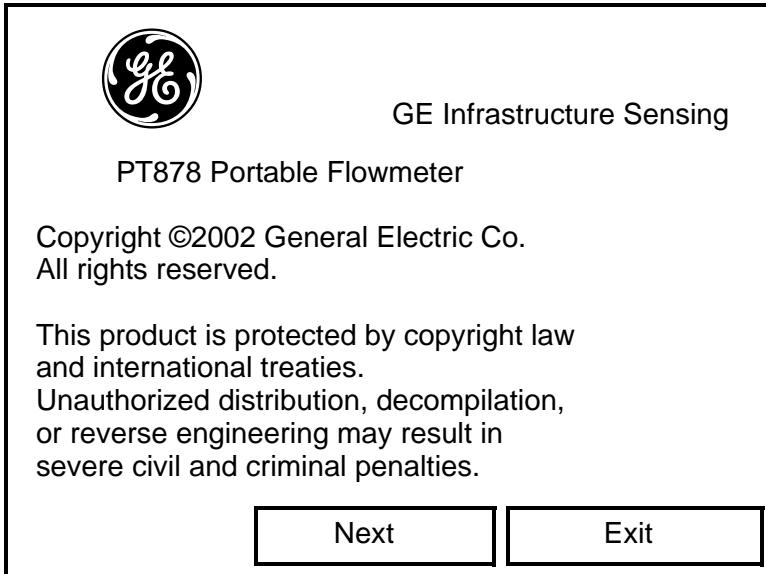

Figure 5-20: The About Window

To return to Operate Mode, press [ESC] or [F3] (Exit).

Chapter 6

Programming Meter Settings

Along with display formats and site data, PT878 users can program global settings for the meter that suit their individual preferences. The global settings include:

- English or Metric measurement units
- Battery power
- Date and time parameters and appearance (locale)
- Screen contrast
- Backlight timeout
- Language settings
- Infrared communications settings
- Resetting forward and reverse totals
- User tables
- Printing a screen
- Taking a bitmap capture of a screen

Entering the Meter Menu

To enter the Meter Menu, press the [MENU] key at the lower right of the PT878 keypad. The Main Menu replaces the Status Bar at the top of the screen. Press the [▶] arrow key twice to scroll from the Site Menu to the Meter Menu. At the Meter Menu, press [ENTER]. The screen appears similar to Figure 6-1 below. While programming, refer to Figure A-4 on page A-4 of Appendix A, *Menu Maps*.

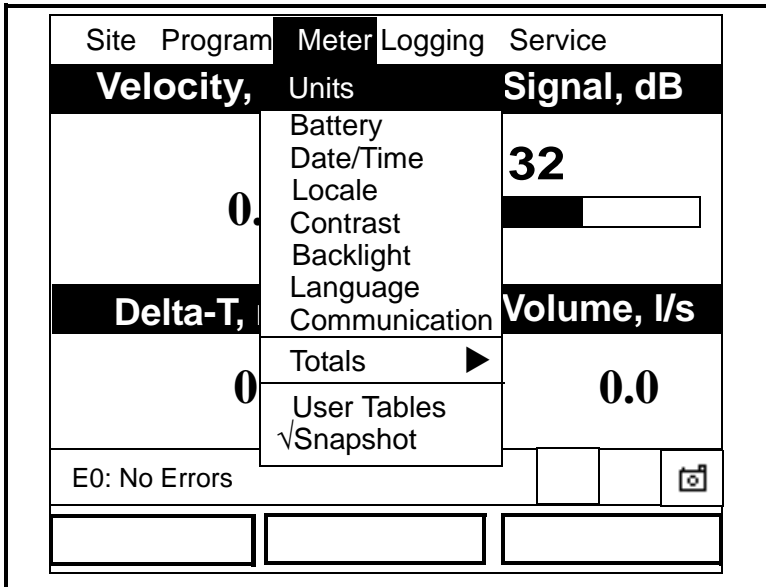

Figure 6-1: The Meter Menu

To scroll to a particular option, press the [▼] or [▲] arrow keys until you reach the option. Then press [ENTER] to open the option window.

When entering parameters in an option, press:

- The [▼] key to step through the available parameters
- The [▲] key to scroll back to a previously entered parameter
- The [F2] key (Cancel) or the [ESC] key to exit an option at any time and return to Operate Mode without changing the parameters.

Selecting Measurement Units

The first option, Units, enables you to select either English or Metric units as global measurement units for the PT878. The selected units then become the default settings for every measurement that has the option for metric/English units. To select the units, scroll to the Units entry on the Meter menu and press [ENTER]. The Meter Settings window opens, as shown in Figure 6-2 below.

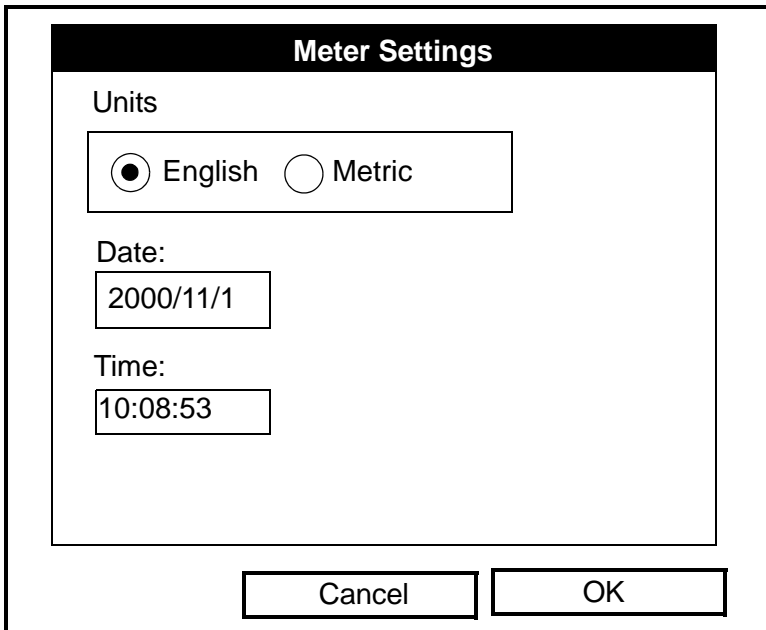

Figure 6-2: The Meter Settings Window

1. Use the [◀] and [▶] keys to scroll between English and Metric units.
2. Press [ENTER] to confirm the choice.

The Battery Charger

The Battery option allows you to monitor the current run time and status of the internal rechargeable batteries, as well as to condition NiCad batteries to maintain the maximum life possible. Conditioning NiCad batteries (a process that can take up to 12 hours for a fully charged pack) discharges the pack completely and then performs a fast charge.

Note: *When conditioning the batteries, be sure you have plugged the AC adapter into the PT878 and pressed the power key. NiMH batteries normally do not require conditioning.*

To open the option window:

1. From the Meter menu, scroll to the Battery entry and press [ENTER]. The Battery Charger window opens, as shown in Figure 6-3 below.
2. If you wish to open the Part Number window, press [ENTER]. You can choose from a 1.8 Ahr NiCd battery (part number 200-058) or a 3.0 Ahr NiMH battery (part number 200-081). Scroll to the battery type you have installed and press [ENTER].

Note: *If you do not set the correct battery type in the Part Number window, the battery continues to function, but the battery status icons (see page 2-5) will not be accurate.*

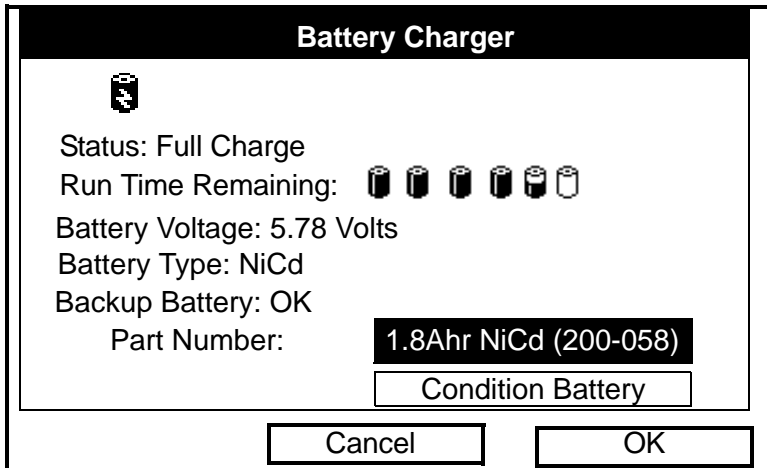

Figure 6-3: The Battery Charger Window

The Battery Charger (cont.)

3. To condition the batteries, press the [ENTER] key. The “Condition Battery” window should now read “Stop.” The status line should change to “Discharging.” (Updating the status could take up to 30 seconds.)

Note: *It is advisable to condition NiCad batteries when their run time is reduced to 50% of their previous run time.*

4. To stop the discharge cycle, press the [ENTER] key and the “Condition Battery” window reappears. The status now changes to “On Charger.”
5. Press [F3], OK, to return to Operate Mode.

Entering Date and Time

In Operate mode, the Status Bar displays the current date and time above the measurements in the upper right corner of the screen. The Date/Time option allows you to set the date or time, which are required for correct data logging operation.

To set the time:

1. From the Meter menu, scroll to the Date/Time entry and press [ENTER]. The Meter Settings window reopens, as shown in Figure 6-2 on page 6-3.
2. From the Units option, press the [▼] key once to reach the date text box. This box displays the current meter date.
3. Press [ENTER] to enter the text window. The meter highlights the center number. Use the [◀] and [▶] keys to scroll to any number you wish to change.
4. Two alternatives are available to change a highlighted number:
 - Use the numeric keys to enter the desired number.
 - Use the [▼] or [▲] arrow keys to scroll, in 1-digit increments, to the desired number. (For example, if the text box highlights 09, pressing the [▼] key twice changes the number to 07. You can scroll from 01 to 12 for the month and from 01 to 31 for the day (depending on the number you have selected for the month.)

In either case, press [ENTER] to confirm the entry.

Entering Date and Time (cont.)

To enter or change the time:

1. From the time text box, press the [▼] key once to scroll to the time text box. This box displays the current meter time.
2. Press [ENTER] to enter the text box. The meter highlights the first number. Use the [◀] and [▶] keys to scroll to any number you wish to change.
3. Two alternatives are available to change a highlighted number:
 - Use the numeric keys to enter the desired number.
 - Use the [▼] or [▲] arrow keys to scroll, in 1-digit increments, to the desired number. (For example, if the text box highlights 09, pressing the [▼] key twice changes the number to 07.) You can scroll from 01 to 12 for the hour and from 01 to 59 for the minute and second inputs.
4. In either case, press [ENTER] to confirm the entry.

Pressing the [▼] or [▲] arrow keys causes the meter to scroll within the Meter Settings options.

- To confirm the entries and return to Operate mode, press [F3] (OK). The PT878 returns to Operate Mode.
- To leave the window without confirming the entries, press [F2] (Cancel) or the [ESC] key. The PT878 returns to Operate Mode.

Changing Date and Time Appearance

In addition to setting the correct date and time, you can also change its presentation to suit local preferences. You can select a time display of AM/PM or 24-hour time.

To alter the time and date display:

1. From the Meter menu, scroll to the Locale entry and press [ENTER]. The Display Options window opens on the Format tab, as shown in Figure 6-4 below. To step through each parameter, press the [▼] key.

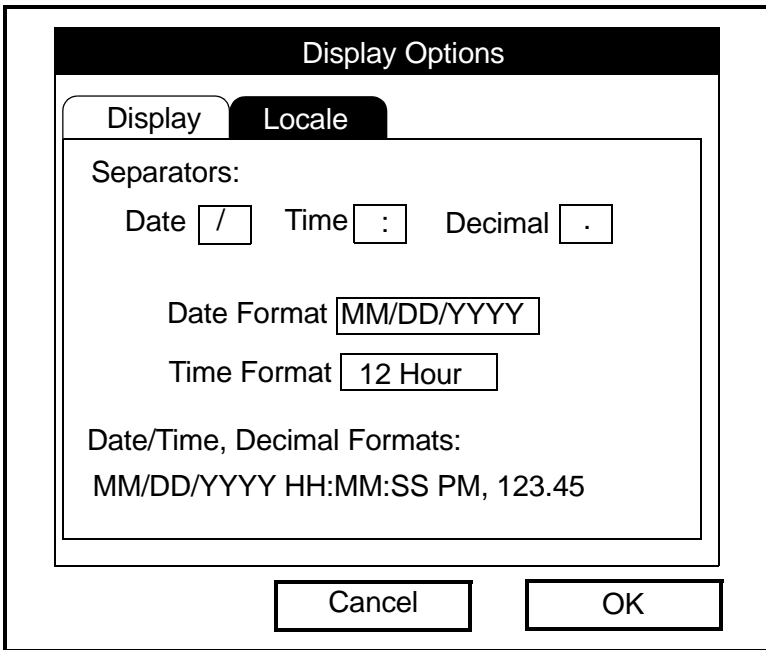

Figure 6-4: Format Tab in the Display Options Window

Changing Date and Time Appearance (cont.)

2. The first series of prompts asks you to select separator symbols for the date, time and decimal. You can choose from a dash, comma and slash (/) for the date; from a period and colon for the time; and from a period or comma for the decimal place. For each symbol type:
 - a. Press [ENTER] to open the drop-down menu.
 - b. Use the [▼] or [▲] arrow keys to scroll to the desired format.
 - c. Press [ENTER] to confirm your entry.
3. The next prompt asks you to select the date format.
 - a. Press [ENTER] to open the drop-down menu. Three options are available:
 - YYYY/MM/DD (year/month/day)
 - MM/DD/YYYY (month/day/year)
 - DD/MM/YYYY (day/month/year)
 - b. Use the [▼] or [▲] arrow keys to scroll to the desired format.
 - c. Press [ENTER] to confirm your entry.
4. The PT878 now asks you to select whether you want the time presented in a 12-hour format (for example, 11:53:23 PM) or in a 24-hour format (23:53:23).
 - a. Press [ENTER] to open the drop-down menu.
 - b. Use the [▼] or [▲] arrow keys to scroll to the 12-hour or 24-hour entry.
 - c. Press [ENTER] to confirm your entry.

Changing Date and Time Appearance (cont.)

A line at the bottom, the Date/Time, Decimal Formats, displays how the format and separator selections will appear on the screen.

Pressing the [▼] arrow key returns the PT878 to the Locale tab.

- To confirm the entries and return to Operate mode, press [F3] (OK). The PT878 returns to Operate Mode.
- To leave the window without confirming the entries, press [F2] (Cancel) or the [ESC] key. The PT878 returns to Operate Mode.

Adjusting the Contrast

For more comfortable viewing in a particular environment, the PT878 enables you to adjust the screen contrast. To adjust the screen contrast:

1. From the Meter menu, scroll to the Contrast entry and press [ENTER]. The Display Options window opens on the Display tab, as shown in Figure 6-5 below. (From the Format tab, press the [◀] key to move to the Display tab.) To step through each parameter, press the [▼] key.

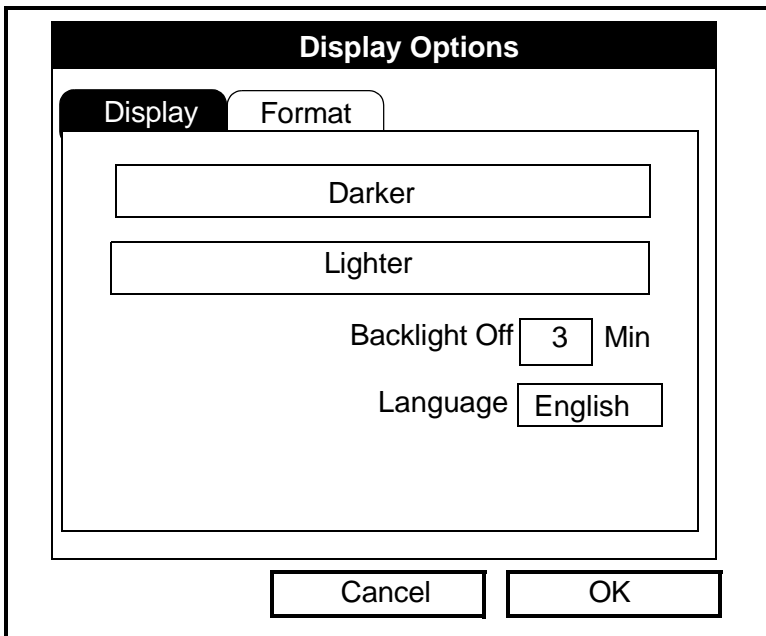

Figure 6-5: Display Tab in the Display Options Window

2. Scroll to the Darker or Lighter box as desired.
3. Press the [ENTER] button repeatedly until the screen has the desired contrast.

Note: *If you find the screen has become too light or too dark, scroll to the other box and press [ENTER] until you have adjusted the screen to your satisfaction.*

Adjusting the Contrast (cont.)

- To confirm the entries and return to Operate Mode, press [F3] (OK). The PT878 returns to Operate Mode.
- To leave the window without confirming the entries, press [F2] (Cancel) or the [ESC] key. The PT878 returns to Operate Mode.

Setting Backlight Timeout

By using the Backlight Timeout option, you can set a specified time that the PT878 backlight will remain on before turning itself off. Automatic turnoff enables the PT878 to conserve battery power.

To set the backlight timeout:

1. From the Meter menu, scroll to the Backlight entry and press [ENTER]. The Display Options window opens on the Display tab, as shown in Figure 6-5 on page 6-11.
 2. Press the [▼] key three times to reach the Backlight Off text box.
 3. Then press [ENTER] to enter the box.
 4. Use the numeric keys to enter the number of minutes that the backlight remains on (from 0 to 99).
 5. Press [ENTER] to confirm the entry.
- To confirm the entries and return to Operate mode, press [F3] (OK). The PT878 returns to Operate Mode.
 - To leave the window without confirming the entries, press [F2] (Cancel) or the [ESC] key. The PT878 returns to Operate Mode.

Note: *You can turn the backlight on or off at any time by pressing the power switch for 1 second.*

Changing the Display Language

IMPORTANT: *To use this option, you must have previously loaded a language translation file into the PT878.*

The PT878 offers the selection of several languages for its display. To change the display language:

1. From the Meter menu, scroll to the Language entry and press [ENTER]. The Display Options window opens on the Display tab, as shown in Figure 6-5 on page 6-11.
2. Press the [▼] key four times to reach the Language prompt.
3. Then press [ENTER] to enter the drop-down menu.
4. Scroll to the desired language on the menu, here shown as either English or Francais (French).
5. Press [ENTER] to confirm the entry, and [F3] (OK) to close the option.
6. Since changing the language requires restarting the PT878, a window (shown in Figure 6-6 below) opens, asking that you confirm the change. Press [F2] to cancel the change or [F3] to confirm the change.

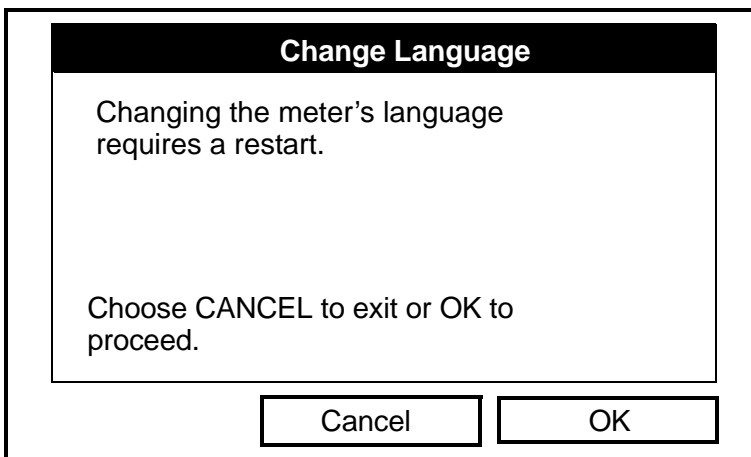

Figure 6-6: Confirmation Window for Language Change

Changing the Display Language (cont.)

The meter restarts in Operate Mode in the desired language. Figure 6-7 below illustrates a French version of the display shown in Figure 5-3 on page 5-4.

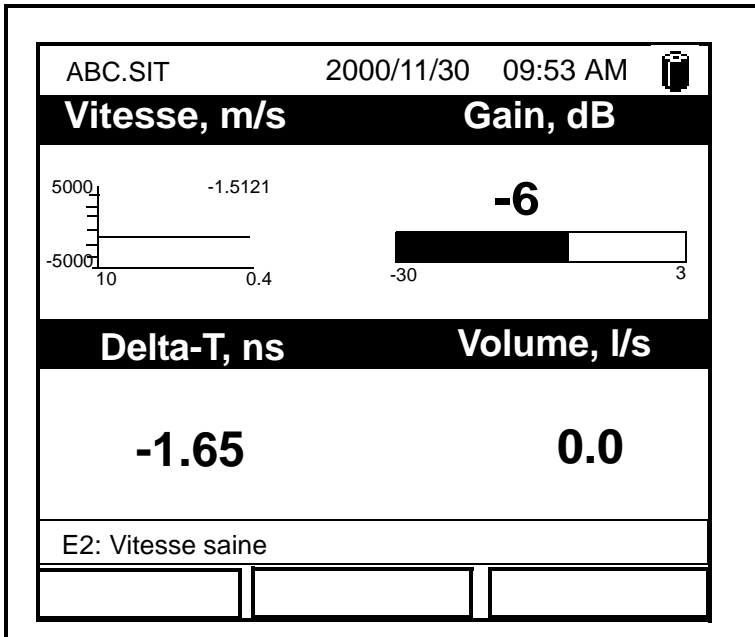

Figure 6-7: French Version of Typical Display

Note: *The PT878 defaults to US English. However, one or more alternate languages can be installed at any time. Consult your GE Infrastructure Sensing representative or www.gesensing.com for available languages.*

Changing Communications Parameters

On occasion, you might need to change the parameters by which the PT878 communicates with a PC over the wireless infrared interface. While programming, refer to Figure A-17 on page A-17 of Appendix A, *Menu Maps*. To check or change these parameters:

1. From the Meter menu, scroll to the Communications entry and press [ENTER]. The Communications window appears similar to Figure 6-8 below.

The screenshot shows a window titled "Communications" with the following settings:

- Node ID: 2
- Comm Interface: IrDA IR 232
- Baud Rate: 9600 bps
- Parity: None
- Stop Bits: 1 2
- Data Bits: 7 8

At the bottom of the window are two buttons: "Cancel" and "OK".

Figure 6-8: The Communications Window

2. The first prompt asks for the node identification number, which can be any number from 1 to 240. *Do NOT change the node ID unless instructed by GE Infrastructure Sensing.*
 - a. Press [ENTER] to open the text box.
 - b. Use the numeric keys to enter the node ID.
 - c. Press [ENTER] to confirm the entry.

Changing Communications Settings (cont.)

3. The next prompt asks you to select the communications interface from two options: IrDA (Infrared Data Association) and the IR232 virtual interface. You must use IrDA when using an IR printer or transfer application such as QuickBeam. Use the [◀] and [▶] keys to scroll to the desired selection, and press [ENTER].

Note: *For more information on loading software updates via IrDA, see Chapter 8, Servicing the PT878, page 8-42.*

4. The program now asks for the baud rate. The default rate is 9600 bps.
 - a. Press [ENTER] to open the drop-down menu.
 - b. Use the [▼] or [▲] arrow keys to scroll to the desired rate, from 300 to 115.2K bps.
 - c. Press [ENTER] to confirm the entry.
5. The next prompt asks for the parity from five options: None, Mark, Space, Even or Odd. The default parity is None.
 - a. Press [ENTER] to open the drop-down menu.
 - b. Use the [▼] or [▲] arrow keys to scroll to the desired parity.
 - c. Press [ENTER] to confirm the entry.
6. The next prompt asks you to select either one or two stop bits. The default number is one. Use the [◀] and [▶] keys to scroll to the desired number, and press [ENTER].
7. The final prompt asks you to select either seven or eight data bits. The default number is 8. Use the [◀] and [▶] keys to scroll to the desired number, and press [ENTER].

Changing Communications Settings (cont.)

IMPORTANT: *Using IR232 requires the following parameters:*

- *Baud Rate -- 9600*
 - *Parity -- None*
 - *Stop Bits -- 1*
 - *Data Bits -- 8*
- To confirm the entries and return to Operate Mode, press [F3] (OK). The PT878 returns to Operate Mode.
 - To leave the window without confirming the entries, press [F2] (Cancel) or the [ESC] key. The PT878 returns to Operate Mode.

Resetting Forward and Reverse Totals

On occasion, it might be necessary to clear and reset the forward and reverse totals computed by the Forward and Reverse Totalizers. To reset the totals:

1. From the Meter menu, scroll to the Totals entry and press [ENTER]. The window now appears similar to Figure 6-9 below.

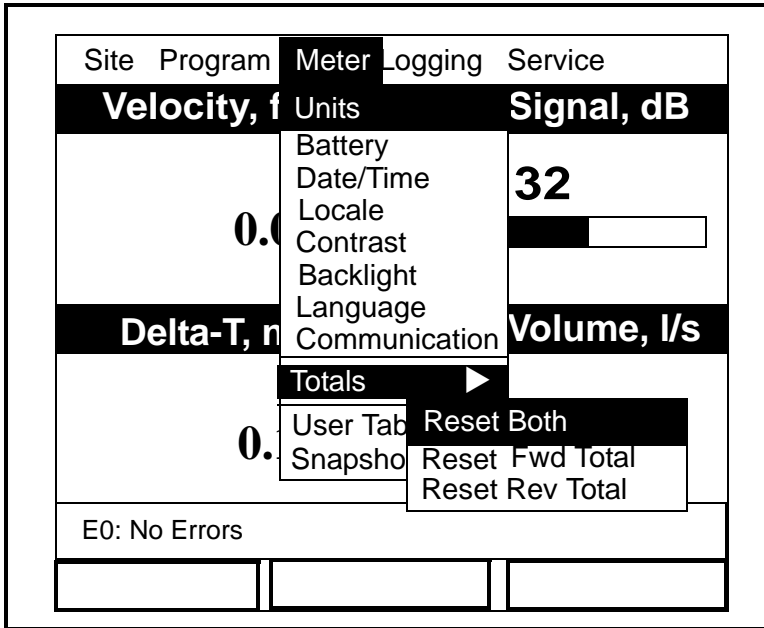

Figure 6-9: The Resetting Totals Menu

2. Use the [▼] or [▲] arrow keys to choose the total to be reset.
3. Press [ENTER] to reset the total(s).

The meter resets the selected total(s) to 0.0 and returns to Operate Mode.

Setting Up User Tables

When you program user functions (see page 3-38), you can also support them with up to six user tables of non-linear or empirical data. To program one or more user tables:

1. From the Meter menu, scroll to the User Tables entry and press [ENTER]. The window now appears similar to Figure 6-10 below.

The screenshot shows a window titled "User Function Tables". Inside the window, there are four input fields arranged vertically. The first field is labeled "Table" and contains the text "Table 1". The second field is labeled "Table ID" and contains the text "UserTable1". The third field is labeled "# Data Points" and is empty. The fourth field is labeled "Max Points" and is empty. Below these fields is a button labeled "Edit Tables". At the bottom of the window, outside the main content area, are two buttons: "Cancel" on the left and "OK" on the right.

Figure 6-10: The User Tables Window

2. The first prompt asks you to select the table to be programmed.
 - a. Press [ENTER] to open the drop-down menu.
 - b. Use the [▼] or [▲] arrow keys to scroll to the table you wish to program.
 - c. Press [ENTER] to confirm the entry.

Setting up User Tables (cont.)

3. The next step is to create a Table ID.
 - a. Press [ENTER] to open the window. The screen now appears similar to Figure 6-11 below.

The screenshot shows a window titled "UserTable1". Inside the window is a grid of characters and symbols. The grid is as follows:

A	B	C	D	E	F	G	H	I	J
K	L	M	N	O	P	Q	R	S	T
U	V	W	X	Y	Z	0	1	2	3
4	5	6	7	8	9	.	,	"	'
=	<	>							

Below the grid are three buttons: "Delete", "Cancel", and "OK".

Figure 6-11: The Text Creation Window

- b. Use the four arrow keys to scroll to the desired letter or symbol, and press [ENTER] to add the letter to the label.
- Note:** *Pressing [SEL] causes the screen to alternate between a set of upper-case (capital) letters and a set of symbols. Use both screens to create the desired label.*
- c. Repeat this procedure for each letter or symbol you wish to add to the label. If you wish to delete a letter, press [F1] (Delete) to erase each letter or symbol, from right to left on the label.
 - d. When you have completed the label, press [F3] (OK) to confirm the label, or [F2] (Cancel) to leave the window without adding the label.

Setting up User Tables (cont.)

Note: *It is not necessary to enter the “#Data Points” or “Max Points” text boxes.*

4. The final prompt asks you to enter or change data in the user table.
 - a. Press [ENTER] to open the window. The screen appears similar to Figure 6-12 below.

Edit User Table 1		
	UserTable1	Y
1		
2		
3		
4		
5		

Figure 6-12: The Edit User Table Window

- b. Use the four arrow keys to move to the desired entry in the table.
- c. Press [ENTER]. Then use the numeric keys to enter the desired data, which appears in the right corner of the window above the table.
- d. Press [ENTER] to confirm the data, which then appears in the appropriate slot in the table.

Setting up User Tables (cont.)

- e. Repeat steps b, c and d on the previous page until you have completed entering data for the table.

- f. When you have finished, press [F3] (OK) to confirm the entries or [F2] (Cancel) to leave the window without confirming the table.

The program returns to the Edit Tables window.

- To confirm the entries and return to Operate Mode, press [F3] (OK). The PT878 returns to Operate Mode.
- To leave the window without confirming the entries, press [F2] (Cancel) or the [ESC] key. The PT878 returns to Operate Mode.

Taking a Bitmap Capture of a Current Screen

The Snapshot option enables you to take a screen capture of the current screen in bitmap format (.bmp) for printing or display or storage in a Windows-based PC. To take a “snapshot” of the screen:

1. From the Meter menu, scroll to the Snapshot entry and press [ENTER].
2. Another menu opens with three entries: Off, To Printer and To File. Scroll to the desired entry and press [ENTER].

Note: *An icon of a printer (for printing capture) or a camera (for file capture — see page 2-11) appears at the far right of the status tray, indicating that you have activated the Snapshot option. Figure 6-1 on page 6-2 shows a screen with the Snapshot option activated.*

3. To capture a screen, press the “.” (decimal) button in the lower left corner of the keypad twice. The meter beeps, indicating that it has made a screen capture.

The program now varies, depending on whether you selected printer or file capture.

- If you selected To Printer, the PT878 shows a message indicating that its infrared sensor is looking for a receiving printer. (If the sensor spots no printer, a window appears indicating that it cannot find a device. If it spots more than one compatible infrared device within its range, it asks you to select the desired device.) It transmits the capture to the printer once it has made a connection.
- If you selected To File, the captured file appears as “Screen 0X.bmp” in the Drive Manager (see page 5-14). To transfer the file to a PC, follow the instructions in *Transferring a File to a PC* on page 5-16.

Chapter 7

Logging Data

A powerful and flexible feature of the PT878 is data logging. The meter enables you to choose up to 12 parameters to log. You can also select the start time and date, end time and date, and time interval. Logs can run one at a time or simultaneously. Error and circular logs are also available. The logged data is internally stored in battery-backed-up memory. A fixed amount of memory is assigned to data logging. The frequency of the time interval, the length of the log run, and the number of logs affect the amount of memory required for a particular log. For example, a log that records every 5 seconds will use up more memory than a log that records every 5 minutes for a given amount of time. Once you make your data logging selections, the PT878 enables you to view the amount of memory left. You may also stop logging or view logged data while or after data is logged.

This section describes:

- How to enter the Logging Menu.
- How to set up a new log.
- How to view the data logger memory.
- How to start, stop or pause logging

Entering the Logging Menu

To enter the Logging Menu, press the [MENU] key at the lower right of the PT878 keypad. The Main Menu replaces the Status Bar at the top of the screen. Press the [▶] arrow key three times to scroll from the Site Menu to the Logging Menu. At the Logging Menu, press [ENTER]. The screen appears similar to Figure 7-1 below. Refer to Figure A-5 on page A-5 of Appendix A, *Menu Maps*.

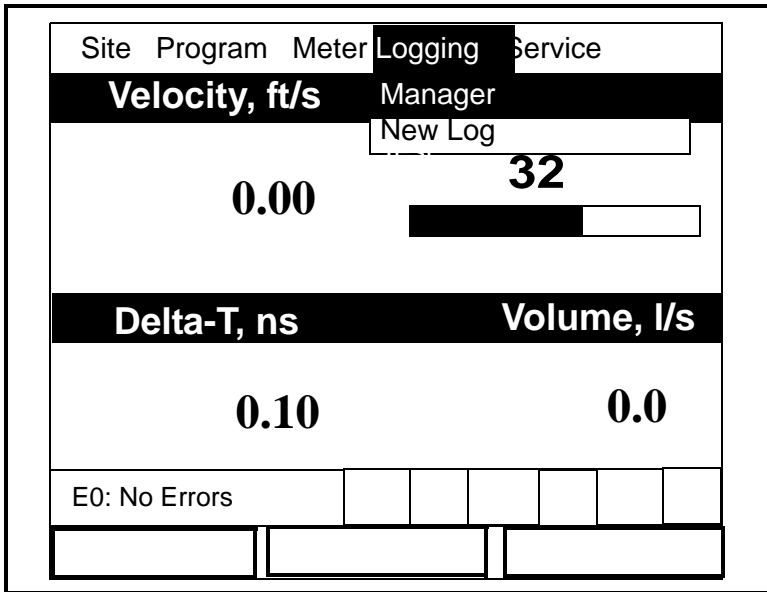

Figure 7-1: The Logging Menu

To scroll to a particular option, press the [▼] or [▲] arrow keys until you reach the option. Then press [ENTER] to open the option window.

When entering parameters in an option, press:

- The [▼] key to step through the available parameters
- The [▲] key to scroll back to a previously entered parameter
- The [F2] key (Cancel) or the [ESC] key to exit an option at any time and return to Operate Mode without changing the parameters.

The Log Manager

The Log Manager offers users a way to check the status and memory size of all the logs currently pending, running or finished. To select Log Manager, scroll to the Manager entry on the Logging Menu and press [ENTER]. The screen appears similar to Figure 7-2 below. The right section of the screen supplies information for the log highlighted in the list on the left. You can use the [▼] and [▲] arrow keys to scroll to a particular log and display information pertaining to that log.

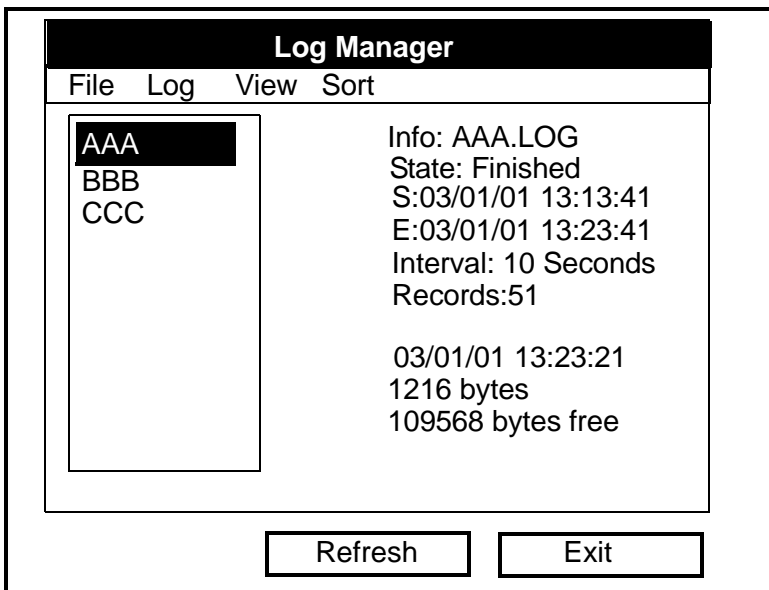

Figure 7-2: The Log Manager Window

To access the menu for the Log Manager, press the [MENU] key. The cursor highlights the File Menu in the upper left corner. Use the [◀] and [▶] keys to scroll to the desired menu, and press [ENTER] to open the menu.

The File Menu

The File menu allows you, not only to create new logs, but also to copy, rename or delete logs, as well as to print them or transfer them to a PC. To open the File Menu from the Log Manager, press the [MENU] key and then [ENTER]. The screen appears similar to Figure 7-3 below.

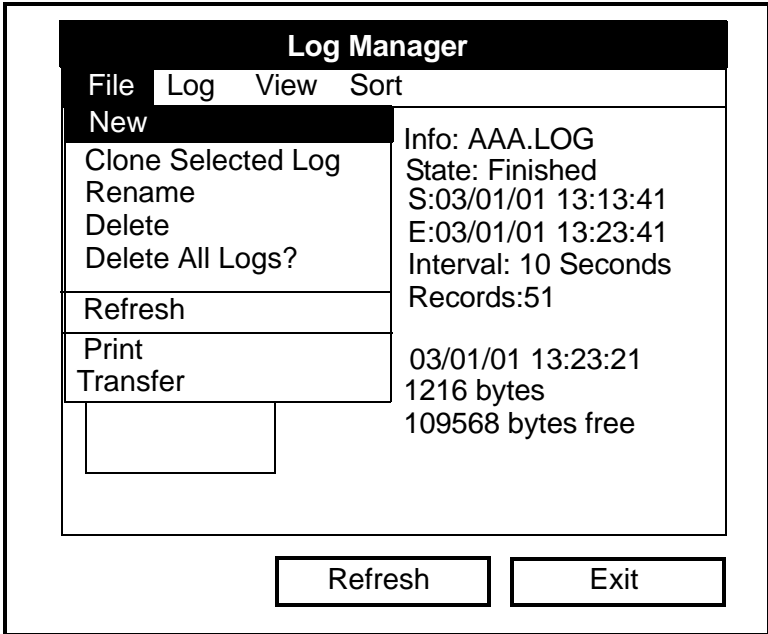

Figure 7-3: File Menu in the Log Manager

Setting up a New Log

The New Log option enables you to create and set up parameters for a new log. You can access this option in two ways:

- by scrolling to the New Log option in the Logging Menu (as shown in Figure 7-1 on page 7-2) and pressing [ENTER], or
- by scrolling to the New option in the File Menu of the Log Manager (as shown in Figure 7-3 on page 7-4) and pressing [ENTER].

In either case, the Create New Log screen appears similar to Figure 7-4 below. Use the four arrow keys to scroll to the desired letter or number, and press [ENTER]. Repeat this procedure until you have created the desired log name. (Press [F1], Delete, to remove any unwanted letters or numbers.) When you have finished, press [F3], OK, to confirm the entry.

Create New Log							
A	B	C	D	E	F	G	H
I	J	K	L	M	N	O	P
Q	R	S	T	U	V	W	X
Y	Z	0	1	2	3	4	5
6	7	8	9	-	_	@	#
&	()					

Delete	Cancel	OK
--------	--------	----

Figure 7-4: The New Log Window

The PT878 now asks for log formatting and measurements. The screen appears similar to Figure 7-5 on page 7-6.

Setting up a New Log (cont.)

The screenshot shows a dialog box titled "General Log Format Window". It has two tabs: "General" (which is selected and highlighted in black) and "Measurements". The "General" tab contains the following fields and controls:

- Log Name:** A text box containing "10SEC.LOG".
- Format:** Two radio buttons. "Linear" is selected (indicated by a filled circle), and "Circular" is unselected (indicated by an empty circle).
- Type:** Two radio buttons. "Standard" is selected (indicated by a filled circle), and "Error" is unselected (indicated by an empty circle).
- Start Date/Time:** Two text boxes. The first contains "2000/11/01" and the second contains "01:38:08".
- End Date/Time:** Two text boxes. The first contains "2000/11/01" and the second contains "09:38:08".
- Logging Interval:** A text box containing "10" followed by the label "secs".

At the bottom of the dialog box are two buttons: "Cancel" and "Activate".

Figure 7-5: The General Log Format Window

To step through each parameter, press the [▼] key.

- 1.** The first prompt asks you to choose between a linear or circular format for the log.
 - a.** Use the [◀] and [▶] keys to scroll to the appropriate radio button.
 - b.** Press [ENTER] to confirm your selection.
- 2.** The next prompt asks you to choose whether the log is to be a standard or error log.
 - a.** Use the [◀] and [▶] keys to scroll to the appropriate radio button.
 - b.** Press [ENTER] to confirm your selection.

Setting up a New Log (cont.)

3. The next prompt asks for the starting date and time.
 - a. Press [ENTER] to enter the text box. The meter highlights the first number. Use the [◀] and [▶] keys to scroll to any number you wish to change, or the [▶] key to scroll to the time box.
 - b. Two alternatives are available to change a highlighted number:
 - Use the numeric keys to enter the desired number.
 - Use the [▼] or [▲] arrow keys to scroll, in 1-digit increments, to the desired number. (For example, if the text box displays 09, pressing the [▼] key twice changes the number to 07.) You can scroll from 01 to 12 for the month and from 01 to 31 for the day (depending on the number you have selected for the month).
 - c. In either case, press [ENTER] to confirm the entry.
4. Follow the same procedure to enter the end date and time.
5. The final prompt in this window asks for the logging interval.
 - a. Press [ENTER] to open the text box.
 - b. Use the numeric keys to enter the desired interval in seconds.
 - c. Press [ENTER] to confirm the entry.
6. You have completed entering parameters in this window. To select the measurements,
 - a. Press the [▼] key to return to the Format prompt.
 - b. Then press the [▲] key to return to the General tab.
 - c. Finally, press the [▶] key to move to the Measurements tab, and press [ENTER]. The Measurements window appears similar to Figure 7-6 on page 7-8.

Setting up a New Log (cont.)

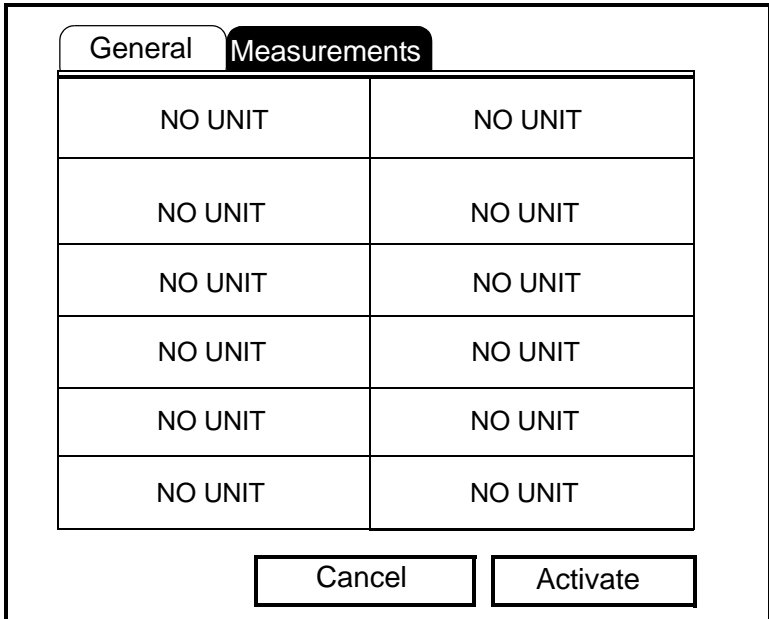

Figure 7-6: The Log Measurements Window

To step through each entry, press the [▼] key.

1. Press [ENTER] to open the first entry. The Select Measurement window opens, as shown in Figure 7-7 on page 7-9.

Setting up a New Log (cont.)

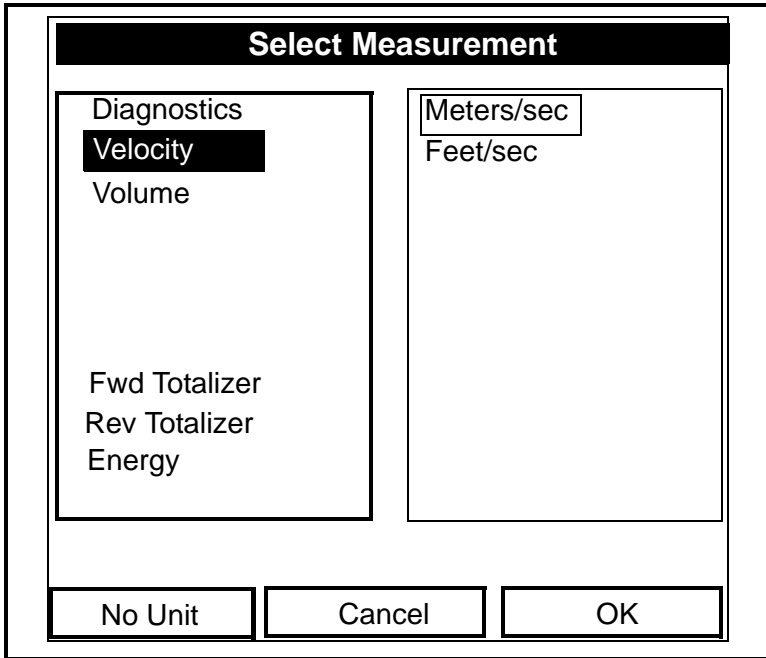

Figure 7-7: The Select Measurement Window

2. Scroll to the desired output type.
3. Press [SEL] to confirm your selection.
4. The prompt then moves to a list of unit types. (The available units depend on the selection made at the Data Source prompt.) Scroll to the desired output unit.
5. Press [F3] (OK) to confirm your selection.
6. You can repeat this procedure for up to 12 different parameters.
7. When you have finished, press [F2] (Cancel) to cancel the entries, or [F3] (Activate) to confirm the entries and start the log.

If you started the log from the New Log option, the PT878 returns to Operate Mode, with a Pencil icon in the System Tray; if you started it from within the Log Manager, the meter returns to the Log Manager.

Copying (Cloning) a Selected Log

In the Clone Selected Log option, you can copy the parameters of a particular log, modify the parameters, and start the copy. To copy a log,

1. First, select the log you wish to copy in the Log Manager (shown in Figure 7-2 on page 7-3).
2. Then open the File Menu, scroll to the Clone Selected Log option, and press [ENTER].
3. The Create New Log window (shown in Figure 7-4 on page 7-5) opens. Follow the procedure discussed on page 7-6 to create a log name, and press [F3] (OK) to confirm the name.
4. The General Log Format window (shown in Figure 7-5 on page 7-6) opens. Follow the procedure discussed on pages 7-6 and 7-7 to change any settings.

Note: *Unless otherwise specified, the cloned log always begins at the current date and time, and ends after the period of time used by the original log.*

5. If you wish, scroll to the Measurements window (shown in Figure 7-6 on page 7-8) and follow the procedure discussed on pages 7-8 and 7-9 to modify any parameters.
6. When you have completed modifying the log parameters, press [F2] (Cancel) to cancel the log or [F3] (Activate) to confirm and start the new log.

The PT878 returns to the Log Manager, which now displays the status of the cloned log.

Renaming a Log

To rename a log:

1. First, select the log you wish to rename in the Log Manager (shown in Figure 7-2 on page 7-3)).
2. Then open the File Menu, scroll to the Rename option, and press [ENTER].
3. The Rename Log window opens. (Except for the heading, the window is identical to the Create New Log window shown in Figure 7-4 on page 7-5.) Follow the procedure discussed on page 7-5 to create a log name, and press [F3] (OK) to confirm the name.

The PT878 returns to the Log Manager, which highlights the renamed log.

Deleting a Log

To delete a log:

1. First, select the log you wish to delete in the Log Manager (shown in Figure 7-2 on page 7-3)).
2. Then open the File Menu, scroll to the Delete option, and press [ENTER].
3. A delete confirmation window opens, as shown in Figure 7-8 on the next page. Press [F2] (No) to stop the deletion, or [F3] (Yes) to delete the log.

The Log Manager reappears, with the specified log deleted.

Deleting a Log (cont.)

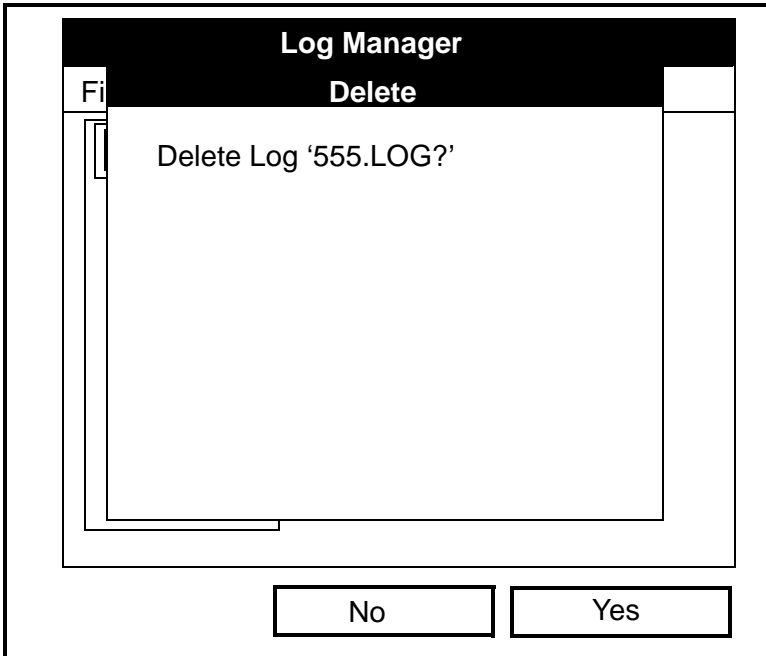

Figure 7-8: The Delete Confirmation Window

Deleting All Logs

To clear the Log Manager and memory of all logs, open the File menu, scroll to the Delete All Logs option, and press [ENTER]. A window opens, asking, "Delete All Logs?" Press [F2] (No) to stop the deletion, or [F3] (Yes) to delete the logs.

A blank Log Manager appears. All logs have been deleted.

Refreshing the Log Manager Screen

To refresh the Log Manager screen and view the most recent information on a given log, select the log you wish to view in the Log Manager. Then open the File Menu, scroll to the Refresh option, and press [ENTER]. The screen momentarily blanks, and then reappears with the most current information on the highlighted log.

Printing a Log

To print a file from the Log Manager:

1. Highlight the desired log in the window on the left of the Log Manager.
2. Press [MENU], scroll to the Print option, and press [ENTER].
3. The Enter Time window opens, as shown in Figure 7-9 below. To determine the exact time period for which you wish to print the log:

Enter Time	
Start Date	Start Time
2003/03/01	13:23:41 PM
End Date	End Time
2003/03/01	13:53:41 PM

Figure 7-9: The Enter Time Window

- a. Use the arrow keys to scroll to the desired text box. Press [ENTER] to open the box.
- b. Two alternatives are available to change a highlighted date or time:
 - Use the numeric keys to enter the desired number.
 - Use the [▼] or [▲] arrow keys to scroll, in 1-digit increments, to the desired number. (For example, if the text box displays 09, pressing the [▼] key twice changes the number to 07.) You can scroll from 01 to 12 for the month, from 01 to 31 for the day (depending on the number you have selected for the month), and from 0 to 59 for minutes and seconds.

In either case, press [ENTER] to confirm the entry.

- c. Repeat step 2 for any other entries you wish to change. When you have finished, press [F3] (OK) to confirm the entries and close the window.

Printing a Log (cont.)

The PT878 shows a message indicating that its infrared sensor is looking for a printer. (If the sensor spots no printer, a window appears with this message. If it spots two printers within its range, it asks you to select the desired device.) If successful, the PT878 returns to the Log Manager, while the printer prints out the log.

Transferring a Log to a PC

To upload a log to a PC:

1. Check that the Communications option (see page 6-16) has been set to the IrDA protocol, and that the IR beam on the PT878 has clear access to the IR sensor connected to the PC port.

Note: *For Windows NT 4.0, check that the QuickBeam software (available through the path C:\Program Files\QuickBeam Suite) is running.*

2. Highlight the desired log in the left window of the Log Manager.
3. Press [MENU], scroll to the Transfer option, and press [ENTER].

The screen shows a message indicating that the PT878 is searching for an infrared device. (If the sensor spots no device, a window appears with this message, and asks if you want to try again.) If it finds a device, it sends another message indicating that it is uploading the log. (The meter also displays a message if the upload fails.) When the upload is complete, the meter returns to the Site Manager. The PC holds the transferred log in a C\Ir_Inbox folder (C:\Ir_Inbox for Windows NT, C:\My Received Files for Windows 98, or Desktop for Windows 2000). You can open the file on the PC using the PanaLog Viewer (available at www.gesensing.com) or PanaView software and export it in Microsoft Excel format.

Note: *You cannot download log files back to the PT878.*

The Log Menu

The Log Menu allows you to pause, restart or end any or all logs that are currently pending or running. (However, you cannot restart any finished logs, even if they were finished before the programmed end time.) To open the Log Menu in the Log Manager, press [MENU]. Scroll to the Log option, and press [ENTER]. The window appears similar to Figure 7-10 below.

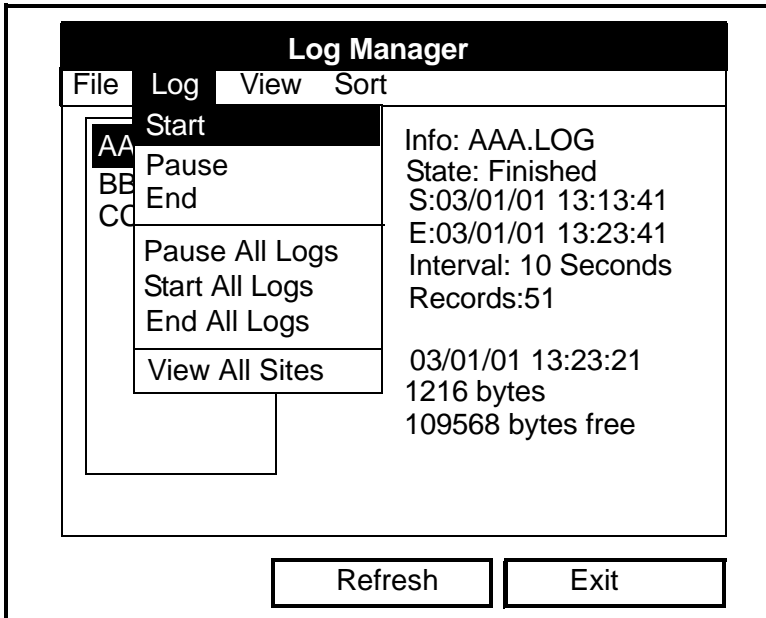

Figure 7-10: The Log Menu in the Log Manager

Stopping (Pausing) a Log

To stop a log that is currently pending or running,

1. First, select the log you wish to pause in the Log Manager (shown in Figure 7-2 on page 7-3).
2. Then open the Log Menu, scroll to the Pause option, and press [ENTER].

The PT878 returns to the Log Manager, which displays the highlighted log with “Paused” in the State line.

Restarting a Log

To restart a paused log:

1. First, select the log you wish to restart in the Log Manager (shown in Figure 7-2 on page 7-3).
2. Then open the Log Menu, scroll to the Start option, and press [ENTER].

The PT878 returns to the Log Manager, which displays the highlighted log with a status of “Pending” or “Running.”

Ending a Log

To end a log:

1. First, select the log you wish to end in the Log Manager (shown in Figure 7-2 on page 7-3).
2. Then open the Log Menu, scroll to the End option, and press [ENTER].

The PT878 returns to the Log Manager, which displays the highlighted log with a status of “Finished.” The space not used by the finished log is freed for reuse.

Note: *You cannot restart a finished log. You must create a new log with the same parameters.*

Stopping All Logs

To stop all log that are currently pending or running, open the Log Menu, scroll to the Pause All Logs option, and press [ENTER]. The PT878 returns to the Log Manager, which displays all log programmed to run now or in the future with a status of “Paused.”

Restarting All Logs

To restart all paused logs, open the Log Menu, scroll to the Start All Logs option, and press [ENTER]. The PT878 returns to the Log Manager, which displays the logs with a status of “Pending” or “Running.”

Ending All Logs

To end all currently pending or running logs, open the Log Menu, scroll to the End All Logs option, and press [ENTER]. The PT878 returns to the Log Manager, which displays the running logs with a status of “Finished.”

View All Sites

To check on all logs, open the Log Menu, scroll to the View All Sites option, and press [ENTER]. Logs are associated with the site in use at the time the log is created. Thus, when another site is in use, the PT878 automatically starts different logs. By default, the Log Manager only displays the logs created with the current site. View All Sites allows the Manager to list logs for all sites.

The View Menu

Through the View menu, you can view the data of individual logs in graphical or spreadsheet formats. To open the View menu from the Log Manager, press [MENU]. Scroll to the View menu, and press [ENTER]. The screen appears similar to Figure 7-11 below.

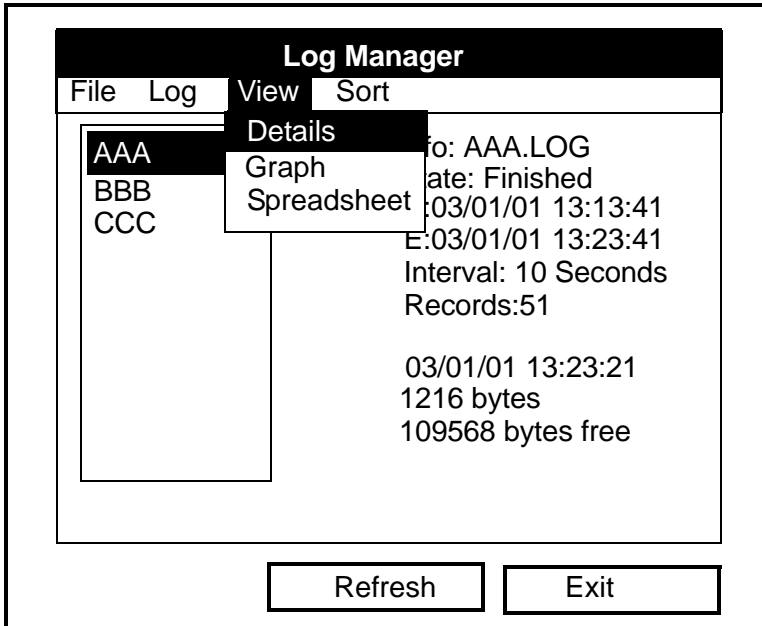
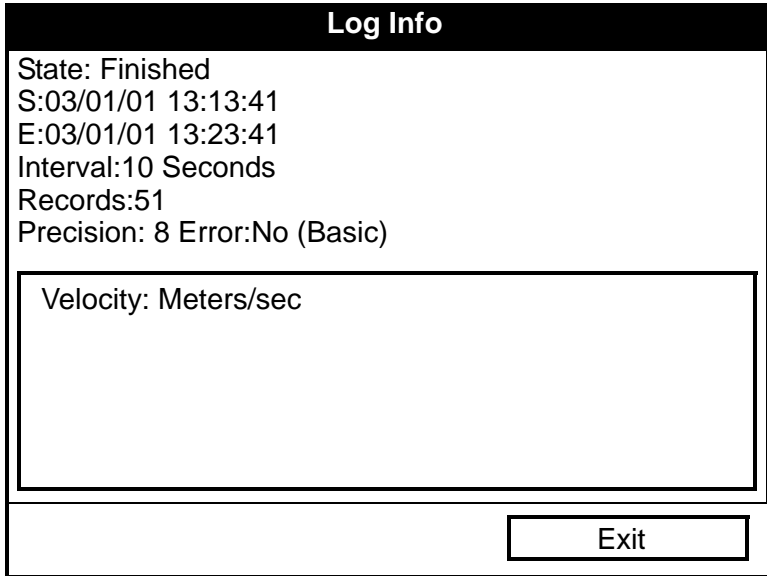

Figure 7-11: The View Menu

Displaying Log Details

To view details of a given log, be sure the log is highlighted in the left window of the Log Manager. Then scroll to the View menu and press [ENTER]. Scroll to the Details option and press [ENTER]. The screen now appears similar to Figure 7-12 below.



The screenshot shows a window titled "Log Info" with a black header. The main area contains the following text:

State: Finished
S:03/01/01 13:13:41
E:03/01/01 13:23:41
Interval:10 Seconds
Records:51
Precision: 8 Error:No (Basic)

Below this text is a large rectangular box containing the text "Velocity: Meters/sec". At the bottom right of the window is a button labeled "Exit".

**Figure 7-12: The Log Details Display Window,
with List of Measurements in the Log**

Press [F2] (Cancel) or [F3] (OK) to return to the Log Manager.

Displaying Log Data in Graphical Form

To view a log in graphical form, be sure the log is highlighted in the left window of the Log Manager. Then scroll to the View menu and press [ENTER]. Scroll to the Graph option and press [ENTER].

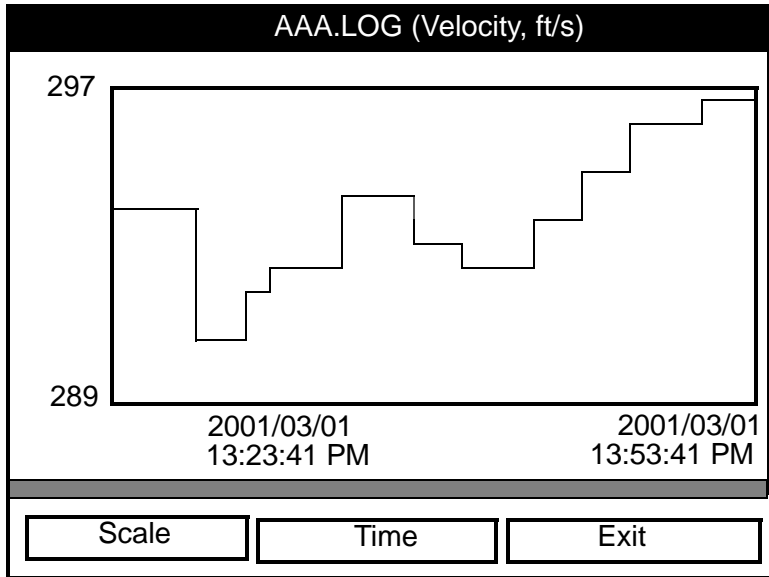

Figure 7-13: The Log Graph Display Window

The Select Measurement window opens and lists the log measurement parameters. If a log contains more than one measurement, you must select which measurement to plot from the list displayed. Once you have chosen the measurement parameter, press [F3] (View). The screen now appears similar to Figure 7-13 above. (Press [F2], Cancel, to leave the window without viewing the graph.)

- If you wish to alter the graph scale, press [F1] (Scale) and go to the next page.
- If you wish to alter the time scale, press [F2] (Time) and go to page 7-22.
- To leave the window, press [F3] (Exit).

Displaying Log Data in Graphical Form (cont.)

Y-Axis

Limits

Max
 Range
 Set

Minimum

Maximum

2003/03/01 13:23:41 PM 2003/03/01 13:53:41 PM

Figure 7-14: The Y-Axis Window

The Y-Axis window (shown in Figure 7-14 above) allows you to specify whether the Y axis on the graph extends to the maximum value (Max), over the entire range (Range) or between certain specified values (Set).

1. Use the [◀] and [▶] keys to scroll to the desired limit type. Press [ENTER] to confirm the entry.

If you select Max or Range for limits, you have finished entering data in this form. But if you select Set, the PT878 asks for minimum and maximum limits.

2. Press the [▼] key to reach the Minimum text box.
 - a. Press [ENTER] to open the text box.
 - b. Use the numeric keys to enter the desired value.
 - c. Press [ENTER] to confirm the entry.
3. Repeat step 2 to enter the Maximum value.
4. When you have finished, press [F2] (Cancel) to cancel the entries, or [F3] (OK) to confirm the entries and change the graph.

Displaying Log Data in Graphical Form (cont.)

If you wish to alter the time scale, press [F2] (Time). The Enter Time window appears similar to Figure 7-15 below.

AAA.LOG (Velocity, ft/s)	
Enter Time	
Start Date	Start Time
<input type="text" value="2003/03/01"/>	<input type="text" value="13:23:41 PM"/>
End Date	End Time
<input type="text" value="2003/03/01"/>	<input type="text" value="13:53:41 PM"/>

Figure 7-15: The Enter Time Window

1. Use the arrow keys to scroll to the desired text box. Press [ENTER] to open the box.
2. Two alternatives are available to change a highlighted date or time:
 - Use the numeric keys to enter the desired number.
 - Use the [▼] or [▲] arrow keys to scroll, in 1-digit increments, to the desired number. (For example, if the text box displays 09, pressing the [▼] key twice changes the number to 07.) You can scroll from 01 to 12 for the month, from 01 to 31 for the day (depending on the number you have selected for the month), and from 0 to 59 for minutes and seconds.

In either case, press [ENTER] to confirm the entry.

3. Repeat step 2 for any other entries you wish to change.

When you have finished, press [F3] (OK) to confirm the entries and close the window, or press [F2] (Cancel) to leave the window without changing the entries.

Displaying Log Data in Spreadsheet Form

To view a log in spreadsheet form, be sure the log is highlighted in the left window of the Log Manager. Then scroll to the View menu and press [ENTER]. Scroll to the Spreadsheet option and press [ENTER]. The screen now appears similar to Figure 7-16 below.

123.LOG	
Time 03/20/2001	Diagnostics P# Up
14:24:46	
14:24:56	450
14:25:06	448
14:25:17	451
14:25:27	453
14:25:37	450
14:25:47	449

Time	Refresh	Exit
------	---------	------

Figure 7-16: The Log Spreadsheet Window

Use the [◀] and [▶] keys to scroll to other columns, or the [▼] or [▲] keys to scroll backward or forward in time.

- To alter the times displayed, press [F1] (Time). The Enter Time window (shown on the previous page) opens. Follow the instructions on the previous page to change the date or time.
- To refresh the display, press [F2] (Refresh). The display shows the most current data.
- Press [F3] (Exit) to return to the Log Manager.

The Sort Menu

The Sort Menu within the Log Manager allows you to arrange your log list either alphabetically (By Name) or chronologically (By Date).

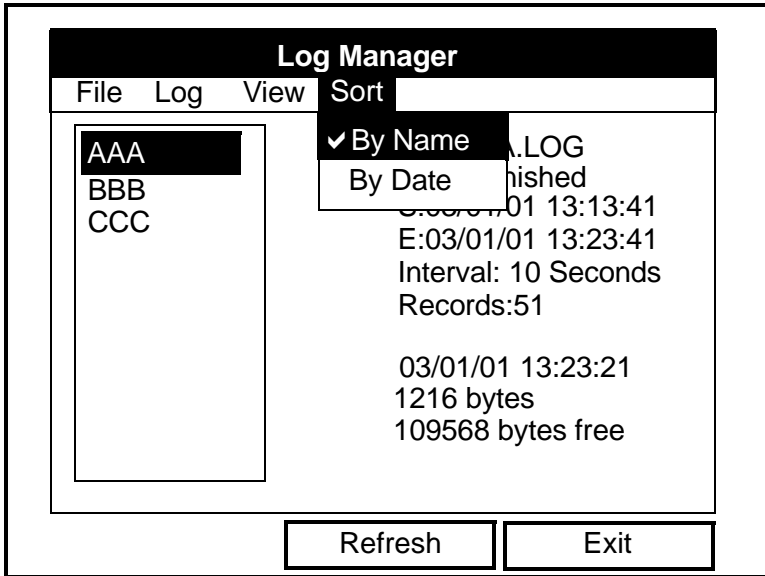

Figure 7-17: Sort Menu in the Log Manager

Listing Logs by Name

If you want to list your logs alphabetically by log name within the Log Manager, press [MENU] to open the File Menu. Then scroll from the File Menu to the Sort Menu, shown in Figure 7-17 above. Press [ENTER]. The Log Manager screen refreshes, with the sites listed in alphabetical order.

Listing Logs in Chronological Order

If you prefer to list your logs chronologically by time of creation within the Log Manager, press [MENU] to open the File Menu. Then scroll from the File Menu to the Sort Menu, and scroll to the By Date option. Press [ENTER]. The Log Manager screen refreshes, with the sites listed in chronological order, from the most recent to the earliest.

Chapter 8

Servicing the PT878

For user convenience, the PT878 offers a Service Menu. This menu enables users to perform a variety of functions that they might occasionally require:

- print out reports
- set up and view the thickness gauge measurements
- calibrate the PT878
- run diagnostics
- set up signal parameters and peak detection
- define error limits
- test the PT878 screen and keys
- diagnose setup problems with the impulse response
- check test points
- return to factory default parameters
- load updated versions of the meter program into the PT878.

Entering the Service Menu

To enter the Service Menu, press the [MENU] key at the lower right of the PT878 keypad. The Menu Bar replaces the Status Bar at the top of the screen. Press the [▶] arrow key four times to scroll from the Site Menu to the Service Menu. At the Service Menu, press [ENTER]. The screen appears similar to Figure 8-1 below. When programming, refer to Figure A-6 on page A-6 of Appendix A, *Menu Maps*.

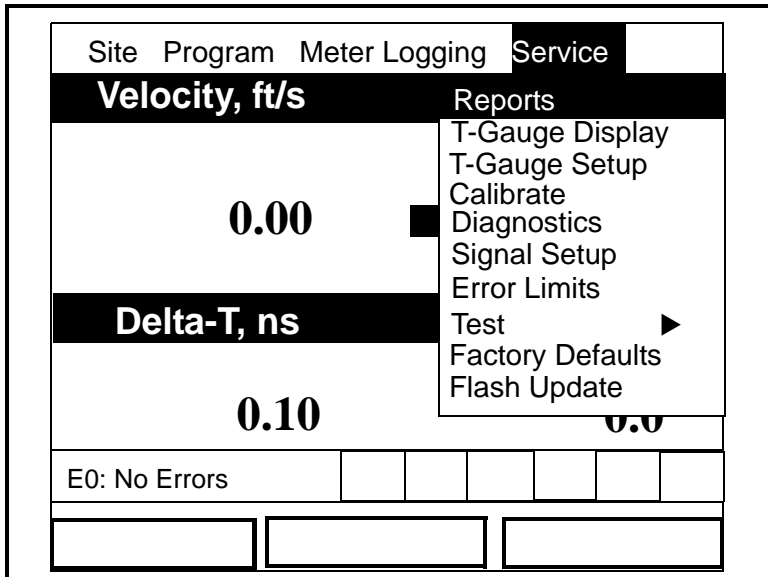

Figure 8-1: The Service Menu

To scroll to a particular option, press the [▼] or [▲] arrow keys until you reach the option. Then press [ENTER] to open the option window.

When entering parameters in an option, press:

- The [▼] key to step through the available parameters.
- The [▲] key to scroll back to a previously entered parameter.
- The [F2] key (Cancel) or the [ESC] key to exit an option at any time and return to Operate Mode without changing the parameters.

Printing Reports

When used with an IR-compatible printer, the PT878 can print out a variety of data (current site, logs, drive contents, and user functions, tables, and settings) in the Reports option. To enter the Reports option, scroll to the Reports entry on the Service Menu and press [ENTER]. The screen appears similar to Figure 8-2 below.

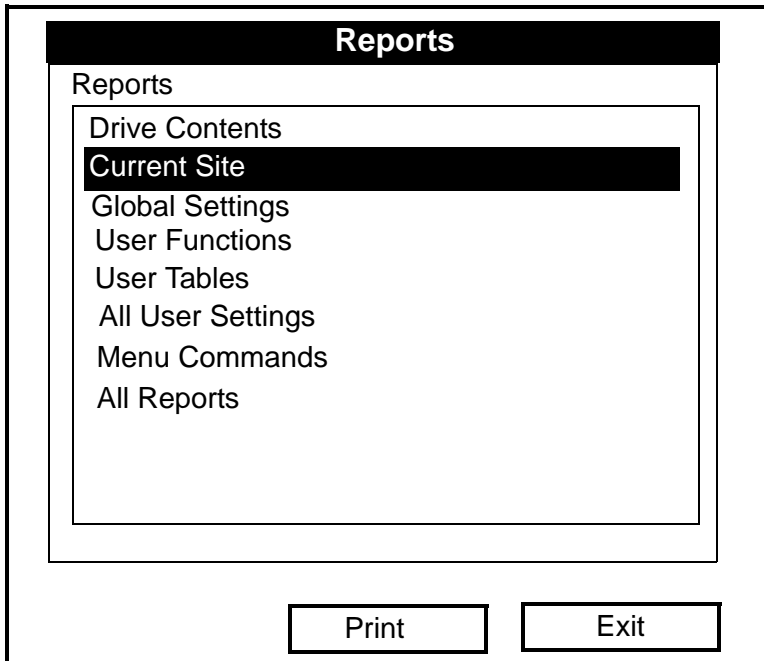

Figure 8-2: The Reports Window

Press [ENTER] to open the drop-down list of available reports, as shown in Figure 8-2 above. Press the [▼] or [▲] arrow keys to scroll to the desired reports, and press [ENTER]. Then press [F2] (Print) to print out the desired reports, or press [F3] (Exit) to leave the option and return to Operate Mode. Figure 8-3 on the next page shows a typical printout of a drive report.

Printing Reports (cont.)

```

-----
Drive Report
-----
Bytes Free: 797696
filename      size      Date:      Time:
-----
Site Files
DEFAULT.SIT  6322      01/09/17   18:19:03
MINILOOP.SIT 7016      01/09/19   17:50:20
WETTED.SIT   7003      01/09/25   14:02:19
STC_2MHZ.SIT 6973      01/09/20   13:17:19
6INEX.SIT    6372      01/09/20   16:11:08
6INST.SIT    6369      01/09/20   16:12:01
2MHZWET.SIT  6982      01/09/26   16:49:10
500KCWET.SIT 6255      01/09/26   16:50:04
3VIEW.SIT    6226      01/09/26   16:49:03
1MHZWET.SIT  6181      01/09/26   16:49:18
4MHZCLMP.SIT 6209      01/09/26   16:49:26
Log Files
LOG01.LOG    161792    01/09/26   19:12:19
Meter Configuration Files
SYSLOG.MET   5506      01/09/26   17:10:26
GLOBAL.MET   1500      01/09/25   18:12:10
-- 1 --

```

Figure 8-3: Printout of a Typical Drive Report

Setting up the Thickness Gauge

For greatest accuracy in flow applications, the PT878 can measure pipe wall thickness using an optional thickness gauge transducer, instead of relying on the nominal pipe wall thickness. In Thickness Gauge mode, the PT878 does not measure flow, but it can determine the thickness of most standard metal and plastic pipe materials over a range from 0.05 to 3 in. (1.3 to 76.2 mm).

The PT878 offers two basic thickness gauge functions: using the gauge to measure thickness after entering the pipe material, and calibrating the gauge. For the highest possible accuracy, you can also calibrate the velocity of the pipe material.

Using the thickness gauge involves three steps:

1. Entering the material and sound speed (in the Material window on the next page),
2. Measuring the pipe wall thickness (in the Display window on page 8-8), and
3. If the measurement seems unreasonable, examining the acoustic signal to diagnose the problem (in the Graph window on page 8-9).

Calibrating the thickness gauge involves up to two additional steps:

4. Calibrating the thickness gauge itself (in the Zero window on page 8-11), and
5. Calibrating the velocity of the pipe material (in the Velocity window on page 8-14), if possible and if the pipe material is not the material entered in the Zero window. This step requires a trustworthy reference, either a section of pipe (such as a flange or open pipe section) that can be measured with calipers or another measurement device, or a thickness calibration block from the same pipe material.

Measuring Pipe Wall Thickness

Entering the Material and Sound Speed

IMPORTANT: *GE Infrastructure Sensing recommends calibrating the thickness gauge periodically (as discussed on page 8-11) before measuring thickness.*

To enter the Thickness Gauge Display option, scroll to the T-Gauge Display entry on the Service Menu and press [ENTER]. The screen appears similar to Figure 8-4 below.

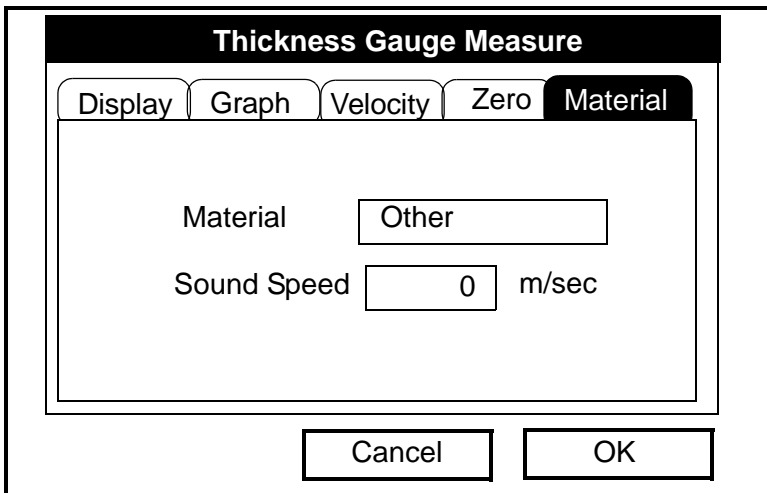

Figure 8-4: The Material Window

1. From the Thickness Gauge Display option, press the [▶] arrow key four times to enter the Material window.
2. The first prompt asks you to select the material for the pipe wall you wish to measure from a drop-down list.
 - a. Press [ENTER] to open the list.
 - b. Use the [▼] or [▲] arrow keys to scroll to the desired material.
 - c. Press [ENTER] to confirm your selection.

Entering the Material and Sound Speed (cont.)

If you have selected a preprogrammed material, you have completed entering data in this window. Pressing the [▼] key returns the program to the Material tab. But if you selected “Other,” you can also enter a specific sound speed.

3. To enter the sound speed:

- a. Press [ENTER] to open the text box.
- b. Use the numeric keys to enter the desired sound speed (from the brochure *Sound Speeds and Pipe Size Data*, 914-004).
- c. Press [ENTER] to confirm your entry.

To leave the Material window:

- Press the [◀] or [▶] arrow key to move to another tab to take readings or perform a velocity calibration.
- Press [F2] (Cancel) to return to Operate Mode without confirming the sound speed value.
- Press [F3] (OK) to confirm the new value. The PT878 returns to Operate Mode.

Measuring Thickness in Numeric Format

To measure the actual thickness of a pipe, hold the calibrated transducer steady, press the [◀] or [▶] arrow key until you reach the Display tab and press [ENTER]. The T-Gauge Display option shows the thickness measurement in numeric format (displayed in Figure 8-5 below).

Note: Refer to Appendix D, Ultrasonic Thickness Gauge Theory of Operation, page D-3, to learn how to position and align the transducer.

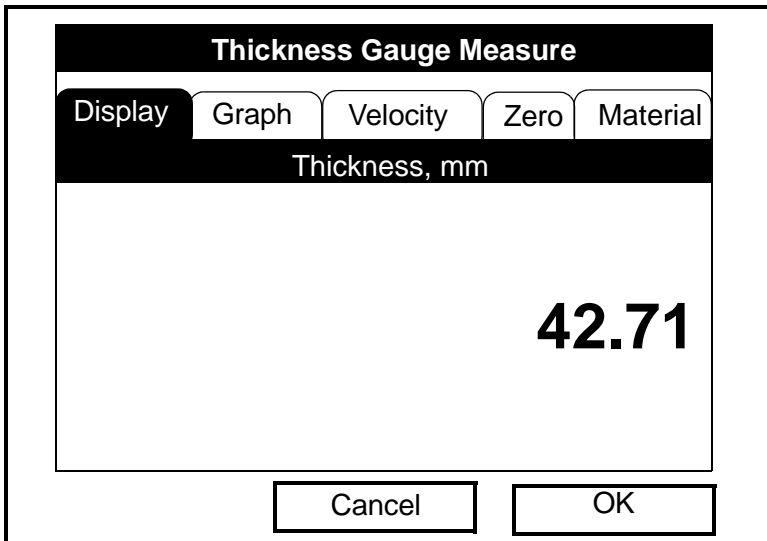

Figure 8-5: The Thickness Gauge Display Window

Be sure the “Noise” or “Los” (loss of signal) boxes do not appear. Press [F2] (Cancel) or [F3] (OK) to return to Operate Mode, or press the [▶] arrow key to move to another window in the option.

Displaying the Receive Signal in Graphical Format

Used chiefly for diagnostic purposes, the Graph option helps to determine why the thickness gauge is not working if you suspect a problem. The graph shows an image of the acoustic signal. If the display does not show a signal image similar to Figure 8-6, you may have a problem with the transducer, couplant, or the programmed values. Also, some materials (such as Teflon[®] or fiberglass) do not support acoustic signals.

To open the Graph window and display the receive signal graphically, press the [◀] or [▶] arrow key until you reach the Graph tab and press [ENTER]. The screen appears similar to Figure 8-6 below.

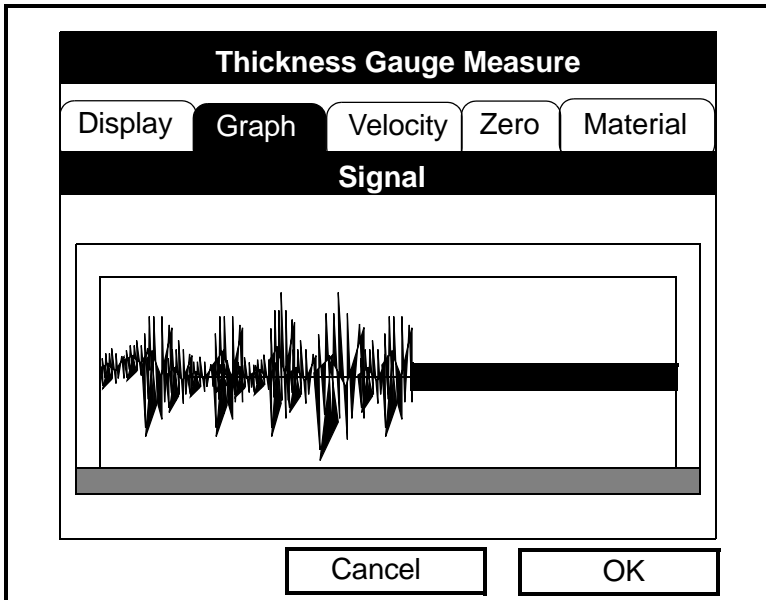

Figure 8-6: The Thickness Gauge Graph Window

Press [F2] (Cancel) or [F3] (OK) to return to Operate Mode, or press the [▶] arrow key to move to another window in the option. However, if you wish to adjust the graph, press the [▼] key. The screen now appears similar to Figure 8-7 on the next page.

Displaying the Receive Signal in Graphical Format (cont.)

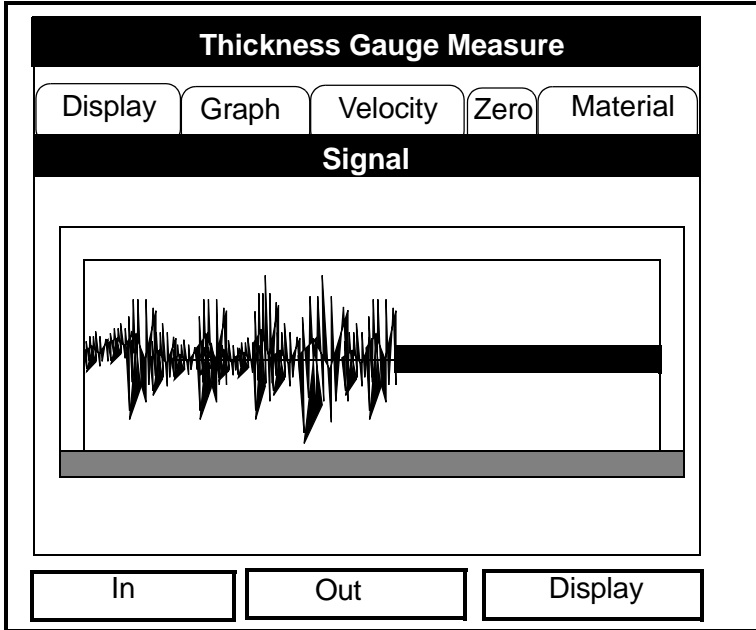

Figure 8-7: The Graph Window in Zoom Format

- Press [F1] (In) to zoom in to magnify screen details.
- Press [F2] (Out) to zoom out fully.
- Press [F3] to toggle between the left and right cursors.
- Press [◀] and [▶] to move the selected cursor left and right.
- Press [▼] to select the graph.
- Press [▲] to return to tab navigation.
- Press [ESC] to return to Operate Mode without saving the calibration changes.

Calibrating the Thickness Gauge Transducer

To zero the transducer offsets, go to the Zero tab. Press the [◀] or [▶] arrow key until you reach the Zero tab and press [ENTER]. The screen appears similar to Figure 8-8 below.

Thickness Gauge Measure

Display Graph Velocity **Zero** Material

Single Dual Calibration

Block 1 Length mm

Transducer Delay, μ s

Calculated Current

Figure 8-8: The Zero Window

Dual-Point Calibration

Note: *GE Infrastructure Sensing recommends dual calibration. Dual-point calibration is more reliable, but it requires two known thickness levels of the calibration material. Use single-point calibration only if you know the velocity of the calibration block material to a high degree of accuracy. For single-point calibration, complete the following procedure, but skip steps 6, 7 and 8. See Appendix D for more information.*

Dual-Point Calibration

1. Press the [▼] arrow key to enter the window.
2. The first prompt asks you to choose between single and dual-point calibration. Use the [◀] and [▶] arrow keys to move to the Dual radio button and press [ENTER].
3. The next prompt asks you to enter the length of Block 1. (If you are using a GE-supplied test block, the length is printed on the block.)
 - a. Press [ENTER] to open the text box.
 - b. Use the numeric keys to enter the length.
 - c. Press [ENTER] to confirm the entry.
4. Press [▶] to move to the Calibrate button, and press [ENTER] to prepare for calibration. Then apply couplant B to the Block 1 surface, and hold the transducer against the block.
5. When you have the transducer firmly pressed against the block and the Ready button appears, press [ENTER] again to perform the calibration.

Note: *For single-point calibration, skip to step 9.*

6. The next prompt asks you to enter the length of Block 2.
 - a. Use the arrow keys to move to the Block 2 text box.
 - b. Press [ENTER] to open the text box.
 - c. Use the numeric keys to enter the length.
 - d. Press [ENTER] to confirm the entry.
7. Press [▶] to move to the Calibrate button, and press [ENTER] to prepare for calibration. Then apply couplant B to the block surface, and hold the transducer against the block.
8. When you have the transducer firmly pressed against the block, press [ENTER] (Ready button) again to perform the calibration.
9. Hold the transducer steady until the Set button appears. Press [ENTER] to store the calibration.

Dual-Point Calibration (cont.)

IMPORTANT: *Be sure to hold the transducer steady until the GE Infrastructure Sensing wait cursor disappears.*

10. Use the [▲] key to return to the Zero tab, and then scroll to the Display tab (page 8-8) to confirm the block length within ± 0.002 . If the measurement is not within this limit, recalibrate the transducer offsets.

Once you have completed calibration, the transducer should remain calibrated until the meter memory is cleared or a dramatic shift in ambient conditions occurs.

To leave the Zero window:

- Press the [◀] or [▶] arrow key to move to another tab to take readings or perform a velocity calibration.
- Press [F2] (Cancel) to return to Operate Mode without confirming the sound speed value.
- Press [F3] (OK) to confirm the new value. The PT878 returns to Operate Mode.

Calculating Velocity (Pipe Material Sound Speed)

The nominal sound speed for your pipe material will give thickness measurements of reasonable accuracy. However, for greater accuracy, calibrate pipe material sound velocity.

IMPORTANT: *This step is necessary only if the actual pipe material sound speed differs from the sound speed of the material used in the calibration block. It is possible only if you have a sample of pipe material with thickness known to a high level of precision.*

To open the Velocity window, press the [◀] or [▶] arrow key until you reach the Velocity tab and press [ENTER]. The screen appears similar to Figure 8-9 below.

The screenshot shows a software window titled "Thickness Gauge Measure". At the top, there are five tabs: "Display", "Graph", "Velocity", "Zero", and "Material". The "Velocity" tab is currently selected and highlighted. Below the tabs, the text "Block Length" is followed by a text input field containing the number "0". A horizontal line separates this section from the next. Below the line, the text "Determine the Sound Speed" is centered. Underneath, there are two labels: "Calculated" and "Current", each followed by an empty text input field. At the bottom of the window, there are two buttons: "Cancel" and "OK".

Figure 8-9: The Sound Speed Window

1. Scroll to the Velocity tab as shown in Figure 8-9 above. Press [ENTER].

Calculating Velocity (Pipe Material Sound Speed) (cont.)

2. To enter the block length (here, the thickness of the sample as measured with a caliper or calibrated sample), press the [▼] arrow key and then press [ENTER] to open the Block Length text box. Use the numeric keys to enter the desired block length. Press [ENTER] to confirm the entry.
3. Prepare the sample for calibration by applying couplant B to its surface, and press [ENTER]. The screen now appears similar to Figure 8-10 below.
4. Hold the transducer steady against the sample, and wait for the Set button to appear.
5. To calibrate the gauge, press the [▼] arrow key to move to the Set button.
6. Press [ENTER] (Set button) to start the calibration sequence.

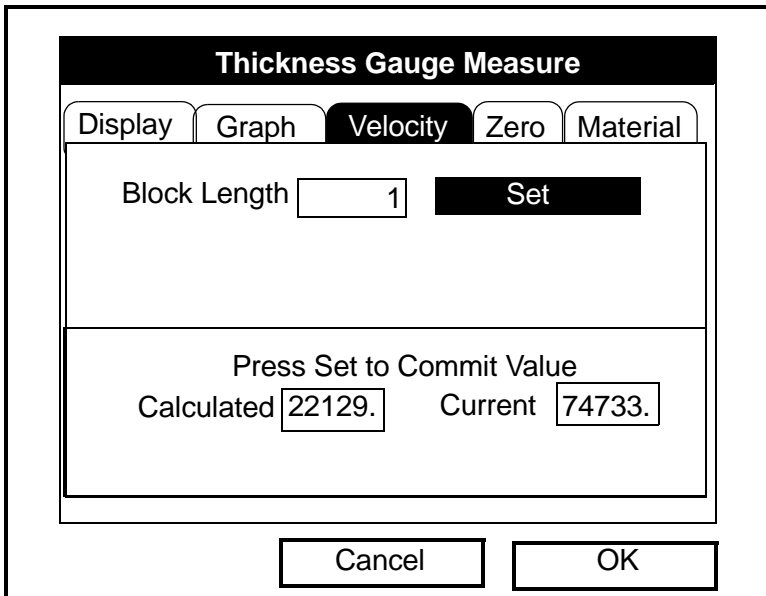

Figure 8-10: The Velocity Window, Displaying the Calculated and Current Values

Calculating Velocity (Pipe Material Sound Speed) (cont.)

7. The “Calculated” box shows the thickness value measured. The PT878 asks for confirmation of the calculated and current values. Press [ENTER] to commit the calculated value, or to recalculate the value.

Note: *If you commit the calculated value, the settings in the Material window also change from the previous material to “Other” with the new sound speed.*

To leave the Velocity window:

- Press the [◀] or [▶] arrow key to move to another tab.
- Press [F2] (Cancel) to return to Operate Mode without confirming the sound speed value.
- Press [F3] (OK) to confirm the new value and return to Operate Mode.

Programming the Thickness Gauge

While the T-Gauge Display option allows you to program the appropriate material and sound speed, the Thickness Gauge Setup option enables you to view or change five parameters:

- Low Signal Threshold
- Transducer Delay
- Signal Inversion
- Noise Threshold
- Detection Threshold

Note: *The thickness gauge programming settings are entered at the factory. You should not change them unless instructed by GE Infrastructure Sensing.*

The Programming window appears similar to Figure 8-11 below.

Thickness Gauge Setup

Programming

Low Signal Thresh %

Transducer Delay μs

Signal Inversion On Off

Noise Threshold %

Detection Threshold %

Cancel OK

Figure 8-11: The Thickness Gauge Programming Window

Programming the Thickness Gauge (cont.)

1. Press the [▼] arrow key to enter the window.
2. The first prompt asks for the low signal threshold. If the signal strength falls below this value, a “Low Signal” message appears on the screen. To change this value:
 - a. Press [ENTER] to open the text box.
 - b. Use the numeric keys to enter the desired value.
 - c. Press [ENTER] to confirm your entry.
3. The next value, transducer delay, represents the time the ultrasonic signal takes to travel from the meter to the pipe material surface. To change this value:
 - a. Press [ENTER] to open the text box.
 - b. Use the numeric keys to enter the desired value.
 - c. Press [ENTER] to confirm your entry.
4. The signal inversion prompt enables you to invert the thickness transducer signal. Signal inversion may be necessary if your thickness readings show unusual jitter, or for certain unusual combinations of pipe and fluid or pipe and lining. Consult the factory before measuring the thickness of lined pipes.

Note: *When measuring the thickness of certain pipe materials, you might need to drain the pipe before measuring the pipe wall, because certain pipe/liquid combinations muffle the ultrasonic echo.*

Signal inversion should be on, unless you have received other instructions. To change its status, use the [◀] and [▶] arrow keys to move to the appropriate radio button and press [ENTER].

5. To enter the noise threshold:
 - a. Press [ENTER] to open the text box.
 - b. Use the numeric keys to enter the desired value.
 - c. Press [ENTER] to confirm your entry.

Programming the Thickness Gauge (cont.)

- 6.** The final value, the detection threshold, represents the percent of peak the PT878 uses to make measurements. It will consider anything above the entered percentage as part of the signal. To change this value:
 - a.** Press [ENTER] to open the text box.
 - b.** Use the numeric keys to enter the desired value.
 - c.** Press [ENTER] to confirm your entry.

You have finished entering values for the Programming window. To leave this window:

- Press the [◀] arrow key to move to the Materials tab.
- Press [F2] (Cancel) to return to Operate Mode without confirming the changes. The PT878 returns to Operate Mode.
- Press [F3] (OK) to confirm the new data and return to Operate Mode. The PT878 returns to Operate Mode.

Displaying Diagnostic Parameters

The Diagnostics option enables you to view current diagnostic parameters without having to open a display window in Operate Mode. To enter the option, scroll to the Diagnostics entry on the Service Menu and press [ENTER]. The screen appears similar to Figure 8-12 below.

Diagnostic Tests		
Meter Error 0x0000	Up	Down
T	430.67	430.67
P#	493	493
Sig Quality	5257	4952
Amplitude	30.4	28.8
Gain	-6.5	-7.0
Count	919	897
Signal	65.9	65.9
Soundspeed m/s	1503.9	
Reynolds #	500	
kRe		0.7704
Delta T		0.69
m/s		0.03
Cancel		OK

Figure 8-12: The Diagnostics Window

Press [F2] (Cancel) or [F3] (OK) to close the window and return to Operate Mode.

Note: For an explanation of diagnostic parameters, refer to Chapter 9, Diagnostics and Troubleshooting.

Calibrating the Analog Output and Inputs

The Calibration option allows you to calibrate the analog output and inputs. To enter the option, scroll to the Calibrate entry on the Service Menu and press [ENTER]. The screen appears similar to Figure 8-13 below.

Calibrate/Test I/O

Analog Output Analog Input

Setpoint

4 mA 20 mA

Actual 4 mA Actual 20 mA

**Figure 8-13: The Outputs Window
in the Calibration Option**

Calibrating the Analog Output

The calibration procedure consists of calibrating the analog output zero point (0 or 4 mA) and then calibrating the full scale point (20 mA). You enter, first the setpoint, and then the actual value derived from an ammeter or digital voltmeter. The analog outputs have a resolution of $\pm 5.0 \mu\text{A}$. Press the [▼] arrow key to enter the Analog Output window.

Calibrating the Analog Output (cont.)

1. Connect the digital multimeter to the analog output.
2. The next prompt asks for the setpoint (4 or 20 mA). Use the [◀] and [▶] arrow keys to move to the appropriate radio button and press [ENTER].
3. The next prompt asks you to enter the actual value shown on the multimeter or ammeter.
 - a. Press [ENTER] to open the text box.
 - b. Use the numeric keys to enter the desired value.
 - c. Press [ENTER] to confirm your entry.
4. Repeat steps 2 and 3 for the other setpoint.
5. Press the [▼] arrow key to move to the Calibrate box, and then press [ENTER] to calibrate the output.

If you are unsatisfied with the calibration, you can reset the inputs to factory defaults. Press the [▶] arrow key to move to the Reset box, and then press [ENTER] to undo the calibration.

You have completed calibrating the outputs. To leave the Output window,

- Press the [▲] key to return to the Output tab, and the [▶] arrow key to move to the Input tab.
- Press [F2] (Cancel) to return to Operate Mode without confirming the changes.
- Press [F3] (OK) to confirm the new data. The PT878 returns to Operate Mode.

Calibrating Inputs

To open the Inputs window, press the [▶] arrow key and press [ENTER]. The screen appears similar to Figure 8-14 below.

Note: *Calibrating the analog inputs requires use of a current source.*

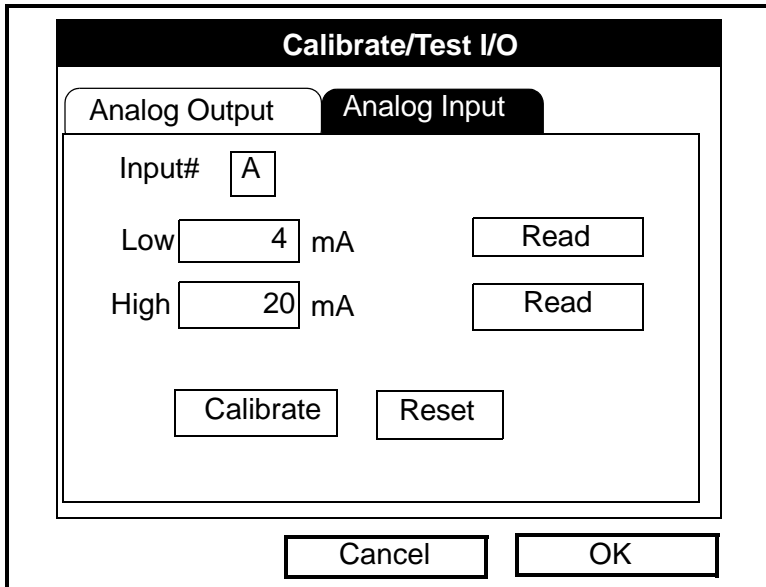

Figure 8-14: The Inputs Window in the Calibrate Option

1. Press the [▼] arrow key to enter the window.
2. The first prompt asks you to select the input.
 - a. Press [ENTER] to open the drop-down list.
 - b. Use the [▼] or [▲] arrow keys to scroll to the desired output (A or B).
 - c. Press [ENTER] to confirm your selection.
3. The next prompt asks for the value to which you want to set the low input (0 or 4 mA).
 - a. Press [ENTER] to open the text box.
 - b. Use the numeric keys to enter the desired value.
 - c. Press [ENTER] to confirm your entry.

Calibrating Inputs (cont.)

4. Press the [▶] arrow key to move to the Read box, and then press [ENTER] to read the low input.
5. The next prompt asks for the value to which you want to set the high input (20 mA).
 - a. Press [ENTER] to open the text box.
 - b. Use the numeric keys to enter the desired value.
 - c. Press [ENTER] to confirm your entry.
6. Press the [▶] arrow key to move to the Read box, and then press [ENTER] to read the high input.
7. Press the [▼] key to move to the Calibrate box, and press [ENTER] to calibrate the inputs.
8. At this point, you have two options:
 - a. If you are unsatisfied with the calibration, you can reset the inputs to factory defaults. Press the [▶] arrow key to move to the Reset box, and then press [ENTER] to undo the calibration.
 - b. If you are satisfied with the calibration, press the [▼] key to return to the Input# prompt, and repeat steps 2 through 8 for the other input.

You have completed calibrating the inputs. To leave the Inputs window,

- Press the [▲] key to return to the Inputs tab, and the [◀] arrow key to move to the Outputs tab.
- Press [F2] (Cancel) to return to Operate Mode without confirming the changes.
- Press [F3] (OK) to confirm the new data. The PT878 returns to Operate Mode.

Setting up Signal Parameters

The Signal Setup option enables you to set parameters that affect the transducer signal:

- Delta-T Offset
- Transmit Sample Size
- Zero Cutoff
- Velocity Averaging
- Errors Allowed
- Peak Detection Method
- Peak Thresholds
- Transmit Code

To enter the option, scroll to the Signal Setup entry on the Service Menu and press [ENTER]. The screen appears similar to Figure 8-15 below.

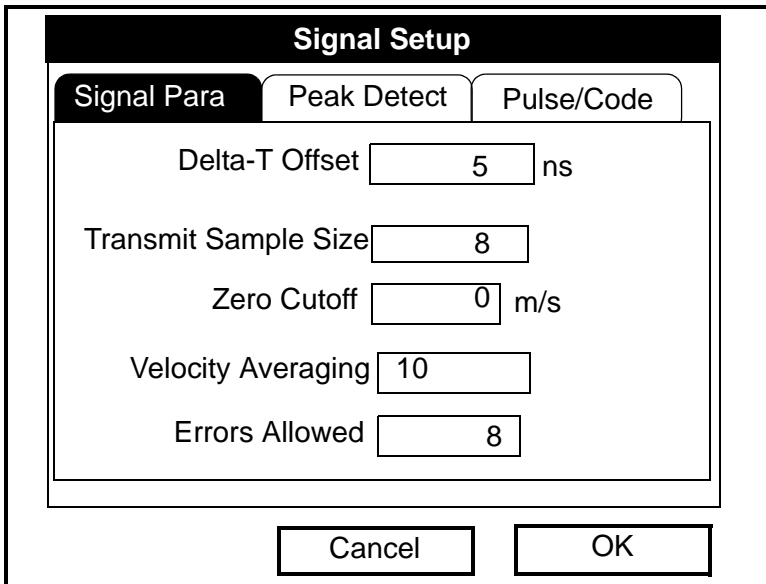

The image shows a screenshot of a 'Signal Setup' window. At the top, the title 'Signal Setup' is displayed in a black bar. Below the title, there are three tabs: 'Signal Para' (which is selected and highlighted in black), 'Peak Detect', and 'Pulse/Code'. The main area of the window contains several parameters, each with a text label and a numeric input field:

- Delta-T Offset: 5 ns
- Transmit Sample Size: 8
- Zero Cutoff: 0 m/s
- Velocity Averaging: 10
- Errors Allowed: 8

At the bottom of the window, there are two buttons: 'Cancel' and 'OK'.

Figure 8-15: The Signal Parameter Window

Setting up Signal Parameters

1. Press the [▼] arrow key to enter the window.
2. The first prompt asks for the Delta-T offset. Delta-T is the difference between the upstream and downstream transit time of the transducers. The Delta-T offset should normally be set to zero.

Note: *Consult GE Infrastructure Sensing before performing this step.*

- a. Press [ENTER] to open the text box.
 - b. Use the numeric keys to enter the desired value.
 - c. Press [ENTER] to confirm your entry.
3. The next prompt, the transmitter sample size, is the number of pulses each transmitter (upstream and downstream) emits. It is set to 8 by default.

Note: *Consult GE Infrastructure Sensing before performing this step.*

- a. Press [ENTER] to open the drop-down list.
 - b. Use the [▼] or [▲] arrow keys to scroll to the desired number.
 - c. Press [ENTER] to confirm your selection.
4. The next prompt asks for the zero cutoff. Near “zero” flow, the PT878 may have fluctuating readings due to small offsets (caused by factors such as thermal drift in the fluid). The zero cutoff causes velocity measurements less than the cutoff to be reported as zero. To set the cutoff:
 - a. Press [ENTER] to open the text box.
 - b. Use the numeric keys to enter the desired value.
 - c. Press [ENTER] to confirm your entry.

Setting up Signal Parameters (cont.)

- 5.** The next prompt asks for velocity averaging.
 - a.** Press [ENTER] to open the drop-down list.
 - b.** Use the [▼] or [▲] arrow keys to scroll to the desired number of velocity measurements to average together to smooth out noise in the system.
 - c.** Press [ENTER] to confirm your selection.

- 6.** The final prompt, errors allowed, specifies the number of errors the meter can record before displaying an error message.
 - a.** Press [ENTER] to open the text box.
 - b.** Use the numeric keys to enter the desired value.
 - c.** Press [ENTER] to confirm your entry.

You have finished entering data in the Signal Parameter window. To leave this window,

- Press the [▼] key to return to the Signal Parameter tab, and the [▶] arrow key to move to the Peak Detection tab.
- Press [F2] (Cancel) to return to Operate Mode without confirming the changes.
- Press [F3] (OK) to confirm the new data. The PT878 returns to Operate Mode.

Setting up Peak Detection

The PT878 can use two different methods to identify the peak of the received signal. In the “Peak” method, the peak is identified by testing a derivative of the signal. In the “Threshold” method, the peak is identified as the point where the signal crosses a threshold that is a percentage of the maximum signal detected. The peak method is more reliable in identifying the signal in dynamic conditions, while the threshold method is more reliable in marginal signal conditions.

Note: *Do not change the peak detection method or values unless recommended by GE Infrastructure Sensing.*

From the Signal Parameter tab, press the [▶] arrow key to move to the Peak Detection tab. The window appears similar to Figure 8-16 below.

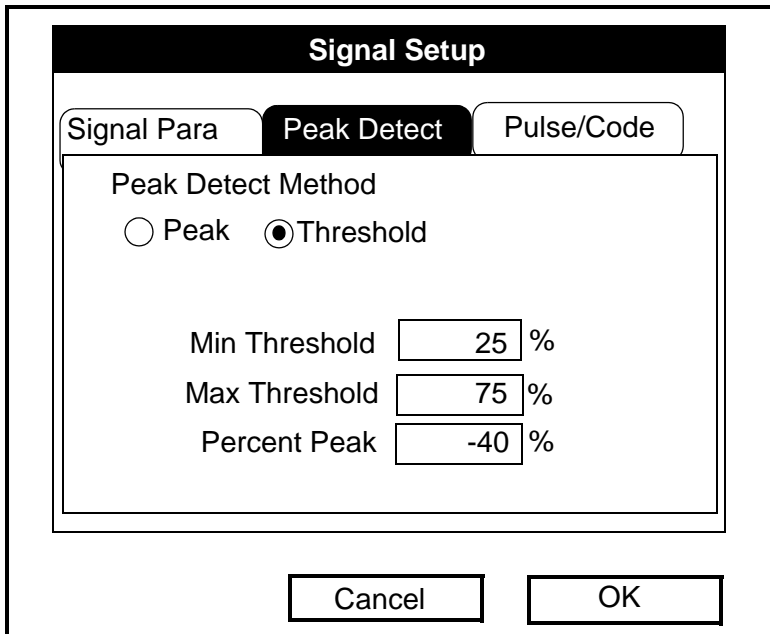

Figure 8-16: The Peak Detection Window in the Signal Setup Option

Setting up Peak Detection (cont.)

1. The first prompt asks for the peak detection method. Use the [◀] and [▶] arrow keys to move to the appropriate radio button and press [ENTER].

If you have selected the peak detection method, you have completed entering data in this window. But if you have selected the threshold method, you must also enter the minimum and maximum threshold percentage (available from 0 to 100) used to measure transit time.

2. To enter the minimum threshold:
 - a. Press [ENTER] to open the text box.
 - b. Use the numeric keys to enter the desired percentage.
 - c. Press [ENTER] to confirm your entry.
3. Repeat step 2 to enter the maximum threshold.
4. The final prompt asks for the percent of peak.
 - a. Press [ENTER] to open the text box.
 - b. Use the numeric keys (and the - key for negative numbers) to enter the desired percentage.
 - c. Press [ENTER] to confirm your entry.

You have completed entering data for Peak Detection. To leave this window,

- Press the [▲] key to return to the Peak Detection tab, and the [◀] arrow key to move to the Signal Parameter tab.
- Press [F2] (Cancel) to return to Operate Mode without confirming the changes.
- Press [F3] (OK) to confirm the new data and return to Operate Mode.

Selecting the Transmit Code

The Pulse/Code tab allows users to select the transmit code used by the PT878 to make measurements. The default option, “Auto,” directs the meter to select the optimal code, based on the pipe size. From the Signal Parameter tab, press the [▶] arrow key twice to move to the Pulse/Code tab, as shown in Figure 8-17 below.

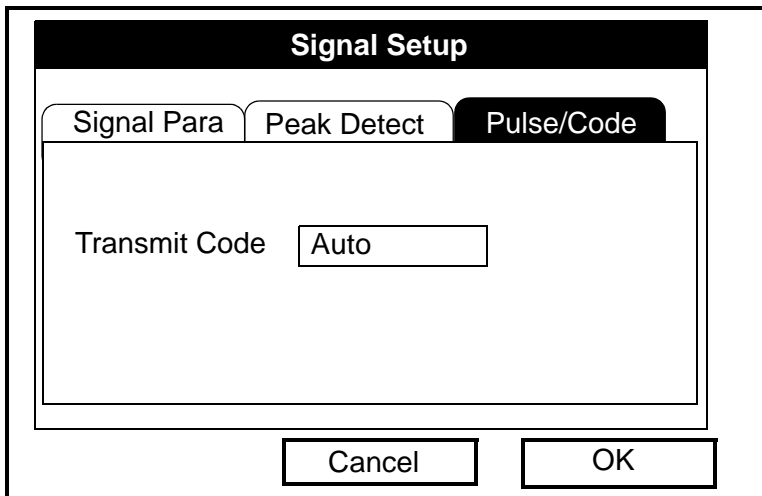

Figure 8-17: The Pulse/Code Window in the Signal Setup Option

1. Press the [▼] arrow key to reach the Transmit Code prompt, and press [ENTER] to open the drop-down menu.
2. Use the [▼] or [▲] arrow keys to scroll to the desired number of pulses (1, 2, 4, 11) or to Auto for automatic code selection.

You have completed entering the Transmit Code. To leave this window,

- Press the [▲] key to return to the Pulse/Code tab, and the [◀] arrow key to move to the Signal Parameter tab.
- Press [F2] (Cancel) to return to Operate Mode without confirming the changes.
- Press [F3] (OK) to confirm the new data and return to Operate Mode.

Setting Error Limits

The Error Limits option enables you to set limits for an incoming signal. When the signal falls outside the programmed limits, an error indication appears. To enter this option, scroll to the Error Limits entry on the Service Menu and press [ENTER]. The screen appears similar to Figure 8-18 below.

Signal Error Limits	
	Min Max
Signal	<input type="text" value="40"/> <input type="text" value="85"/>
Velocity	<input type="text" value="-12"/> <input type="text" value="12"/> m/s
Amplitude	<input type="text" value="10"/> <input type="text" value="34"/>
Sound Speed (±)	<input type="text" value="20"/> %
Acceleration	<input type="text" value="15"/> m/s

Figure 8-18: The Signal Error Limits Option

- The first prompt asks for the minimum and maximum limits for the transducer signal received by the PT878. The default values are 40 for the minimum and 85 for the maximum. The E1: LOW SIGNAL error message appears if the signal strength falls below the limit programmed here.

To enter the minimum signal

- Press [ENTER] to open the text box.
- Use the numeric keys to enter the desired value.
- Press [ENTER] to confirm your entry.

Setting Error Limits (cont.)

- d. Press the [▶] arrow key to move to the maximum signal box, and repeat steps a, b and c.
 - e. Press the [◀] arrow key to return to the minimum signal box, and the [▼] key to move to the next limit.
2. The next prompt calls for the low and high velocity limits. The E3: VELOCITY RANGE error message appears if the velocity falls outside these limits. Repeat Step 1 on the previous page to enter the desired limits.
3. The third prompt calls for the low and high limits for the amplitude discriminator. The discriminator measures the size of the transducer signal sent from the PT878. If the signal falls outside these limits, the E5: AMPLITUDE ERROR message appears. Repeat Step 1 on the previous page to enter the desired limits.
4. The fourth prompt asks for the acceptable limits for the sound speed, based on conditions in your particular system. The E2: SOUND SPEED ERROR message appears if the fluid sound speed exceeds that entered in the Pipe option of the Program menu by more than this percentage. The default value is 20% of the nominal sound speed.
 - a. Press [ENTER] to open the text box.
 - b. Use the numeric keys to enter the desired percentage.
 - c. Press [ENTER] to confirm your entry.
5. The final prompt asks for the acceleration limit for detecting cycle skipping. The E6: ACCELERATION ERROR message appears if the velocity changes by more than this limit from one reading to the next.
 - a. Press [ENTER] to open the text box.
 - b. Use the numeric keys to enter the desired speed.
 - c. Press [ENTER] to confirm your entry.

Setting Error Limits (cont.)

Note: *In the velocity and acceleration boxes, if the PT878 currently displays metric measurements, the F1 softkey displays the word “English.” If it displays English measurements, the F1 softkey displays “Metric.” Press [F1] to display the measurement in the alternate format.*

You have completed entering signal error limits.

- Press [F2] (Cancel) to return to Operate Mode without confirming the error limits, or
- Press [F3] (OK) to confirm the new limits and return to Operate Mode.

The Test Option

Within the Service Menu, the Test option includes seven tests to ensure that the PT878 is performing properly: Test Screen, Test Keys, Watchdog Test, Impulse Response, Wave Snapshot, Simulate and Battery Test. To enter this option, scroll to the Test entry on the Service Menu and press [ENTER]. The screen appears similar to Figure 8-19 below.

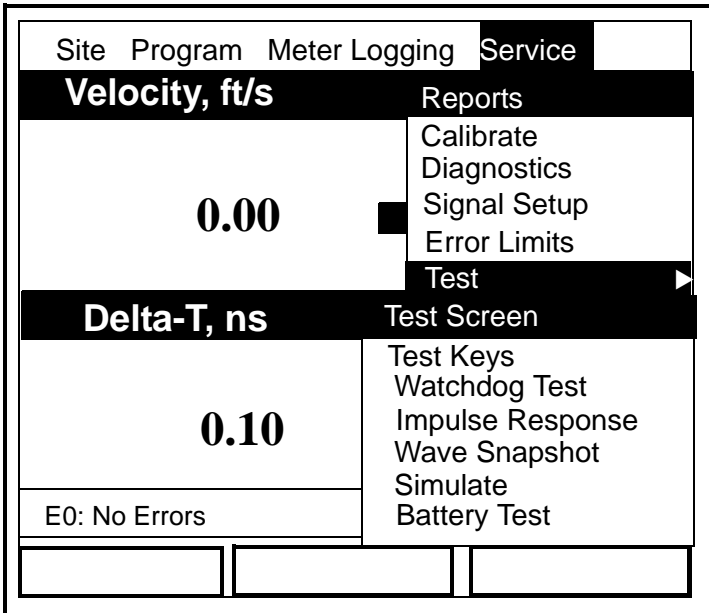

Figure 8-19: The Test Option in the Service Menu

Scroll to the desired entry in the option menu and press [ENTER].

Testing the Screen

To test the proper functioning of the PT878 screen, scroll to the Test Screen option in the Test Menu and press [ENTER]. The screen then shows the message, “Press Any Key To Continue.” Once you press a key, a screen with a checkerboard pattern appears, as shown in Figure 8-20 below.



Figure 8-20: A Functioning Test Screen

Pressing a key two more times should result in two more checkerboard patterns, followed by a series of dark and light screens. Pressing the key through this sequence should return the PT878 to Operate Mode. If the test does not proceed according to this sequence, please consult GE Infrastructure Sensing.

Testing the Keys

The Test Keys option checks the functioning of the various keys on the keypad. To start the test, scroll to the Test Keys option on the Test Menu and press [ENTER]. The screen appears similar to Figure 8-21 below. Press any key on the keypad, and a window representing that key should darken.

Test Keys					
	F1	F2	F3		ⓧ
			?	ESC	SEL
1	2	3		+	
4	5	6	+		+
7	8	9		+	
.	0	-	MENU		ENTER
					Exit

Figure 8-21: The Test Keys Window

Pressing the [F3] key returns the meter to the Operate Mode. If any key does not appear on the screen, contact GE Infrastructure Sensing.

Note: *The power key does not appear.*

Testing the Watchdog Timer Circuit

The PT878 includes a watchdog timer circuit. If a software error causes the meter to stop responding, this circuit automatically resets the meter. A properly functioning PT878 restarts if you run the Watchdog Test.

To start the Watchdog Test, scroll to the Watchdog Test option in the Test Menu and press [ENTER]. The screen appears similar to Figure 8-22 below.

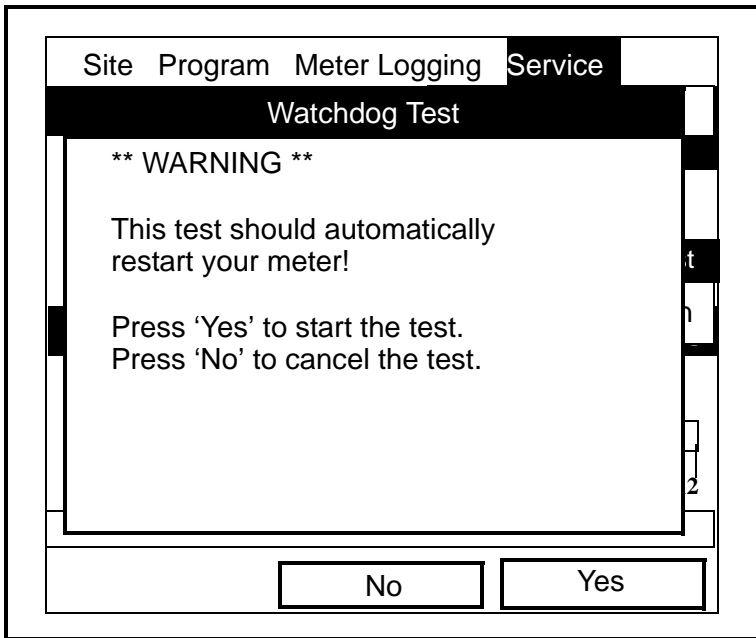

Figure 8-22: The Watchdog Test Screen

Press [F2] (No) to cancel the test and return to the Menu screen, or press [F3] (Yes) to start the test. The PT878 should go blank for a few seconds, and then restart. If it does not follow this sequence, consult GE Infrastructure Sensing.

Setting Impulse Response

The Impulse Response option enables you to force the meter to transmit in one direction only, without changing the AGC setting. You can then diagnose problems with transducer, pipe, or fluid configurations. To enter the option, scroll down to the Impulse Response entry in the Service Menu and press [ENTER]. The screen appears similar to Figure 8-23 below.

The screenshot shows a menu titled "Impulse Response" with a black header. Below the header, there are two input fields: "Direction" with a dropdown menu showing "Upstream" and "Percent Gain" with a text input field showing "20" followed by a "%" symbol. Below these fields, the text "Stopped." is displayed. At the bottom of the screen, there are three buttons: "Transmit", "Stop", and "Exit".

Figure 8-23: The Impulse Response Option

1. The first prompt asks in which direction you wish the meter to transmit, upstream or downstream.
 - a. Press [ENTER] to open the drop-down list.
 - b. Use the [▼] or [▲] arrow keys to scroll to the desired number.
 - c. Press [ENTER] to confirm your selection.

Setting Impulse Response (cont.)

2. The second prompt asks for the percent of gain.
 - a. Press [ENTER] to open the text box.
 - b. Use the numeric keys to enter the desired percentage.
 - c. Press [ENTER] to confirm your entry.

You have completed entering data for the Impulse Response option.

- Press [F1] to start transmitting in the chosen direction.
- Press [F2] to stop transmitting.
- Press [F3] to leave the option and return to Operate Mode.

Taking Wave Samples for Diagnosis

The Wave Snapshot option allows you to capture receive signals to a file that you can send to a PC for diagnostic purposes. To use this option, scroll down to the Wave Snapshot entry in the Service Menu and press [ENTER]. The PT878 then captures three pairs of upstream and downstream raw signals to a file named Wave01.met. (If you repeat the captures, the successive files will be named Wave02.met, Wave03.met, etc.) You can then transfer the files over the IR port to a PC for analysis by a service engineer.

Note: *Refer to page 5-16 for information on transferring a file to a PC.*

Applying a Stored Signal for Diagnosis

The Simulate option places the PT878 in a mode in which it uses a stored signal (instead of the live signal from the transducers) to make flow calculations for diagnostic purposes. On the PC, you must rename a Wavexx.met file as Wave.met and send it back to the PT878 over the IR link. Then, on the PT878, scroll down to the Simulate entry in the Service Menu and press [ENTER]. The PT878 then applies the simulated signal.

Note: *Refer to page 5-17 for information on transferring a file from a PC to the PT878.*

Testing the Battery

The Battery Test option provides additional battery information for service troubleshooting. To enter the option, scroll down to the Battery Test entry in the Service Menu and press [ENTER]. The screen appears similar to Figure 8-24 below.

The screenshot shows a service menu titled "Service Battery Form". It displays the following information:

- Status:** Fast Charge
- Run Time:** 250 Minutes
- Batt Voltage:** 5.78 Volts
- Fast Charge:** 3 Min
- Backup Battery:** OK Batt temp 27.7 °C
- Part Number:** 1.8Ahr NiCd (200-058)
- Condition Battery:** (button)
- Cancel:** (button)
- OK:** (button)

Figure 8-24: The Battery Test Option

The screen displays the current status (Fast Charge, On Charge, Discharging, or On Battery), the time remaining for the PT878 to run on the battery, the time for the Fast Charge, and the current condition of the backup battery.

1. If you wish to open the Part Number window, press [ENTER]. You can choose from a 1.8 Ahr NiCd battery (part number 200-058) or a 3.0 Ahr NiMH battery (part number 200-081). Scroll to the battery type you have installed and press [ENTER].
2. To condition the batteries, press the [ENTER] key. The "Condition Battery" window should now read "Stop." The status line should change to "Discharging." (Updating the status could take up to 30 seconds.)
3. To stop the discharge cycle, press the [ENTER] key and the "Condition Battery" window reappears. The status now changes to "On Charger."
4. Press [F3], OK, to return to Operate Mode.

Resetting to Factory Default Parameters

For various reasons, you might wish to return the PT878 to its original settings. The Factory Defaults option enables you to return the meter to its preprogrammed default settings. To enter the option, scroll down to the Factory Defaults entry in the Service Menu and press [ENTER]. The screen will appear similar to Figure 8-25 below.

Note: *All sites and logs will be lost if you use the Factory Defaults option. Be sure to transfer or print all sites and logs before resetting!*

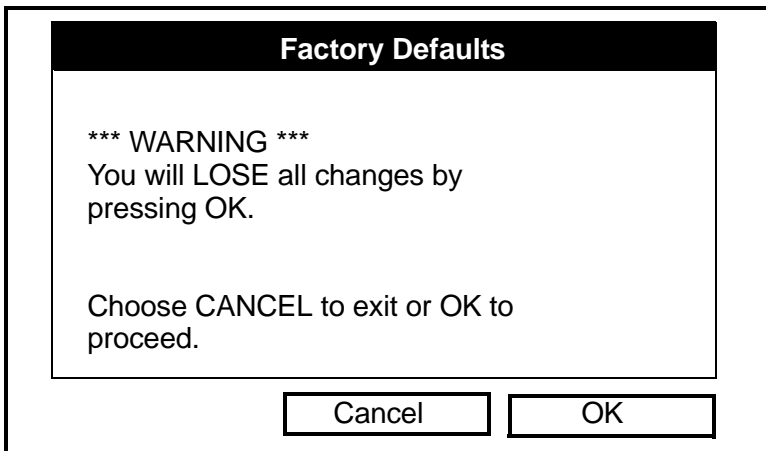

Figure 8-25: The Factory Defaults Option

1. To restore Factory Default settings:
 - Press [F2] (Cancel) to return to Operate Mode without changing the current settings.
 - Press [F3] (OK) to confirm that you wish to restore the factory default settings.
2. The program asks for confirmation: "Are you SURE?" Repeat the procedure shown in Step 1 above.

The PT878 replaces the default site file and the global meter settings with the factory default settings, and returns to Operate Mode.

Updating PT878 Software

By using a Windows-based PC with an infrared adapter, PT878 users can update the meter's operating software without the need to change the hardware. This software can include the bootloader, FPGA software (timing software for transit-time), instrument software, the meter string file and the Help string file. The updating procedure involves three steps:

1. Setting up the PT878 in Flash Update mode.
2. Selecting the loading interface.
3. Loading the new software from the PC into the PT878.

Caution!

To guard against mishap, you should print out, download or otherwise record all logs, settings and other data you wish to save.

IMPORTANT: *When uploading new software, the PT878 uses a "bootloader" program. Be sure that the software you are installing is compatible with the installed bootloader version, shown in the "About" option discussed on page 5-20. If you need to replace both programs, install the new bootloader first, before any other software.*

With the current bootloader software (version 3.0 and later), two interfaces are available for sending software to the PT878:

- IrOBEX, a recently introduced Microsoft infrared standard which allows more straightforward use and faster file transfers, while tolerating IR interruptions better.
- IrCOMM, an infrared standard supported by certain Microsoft operating systems.

GE Infrastructure Sensing recommends updating software via the IrOBEX standard; however, the IrCOMM standard is available for users who have problems with IrOBEX. This section covers procedures for both standards.

Updating Software Via IrOBEX

To begin updating software via IrOBEX, scroll down to the Flash Update entry in the Service Menu and press [ENTER]. The screen appears similar to Figure 8-26 below.

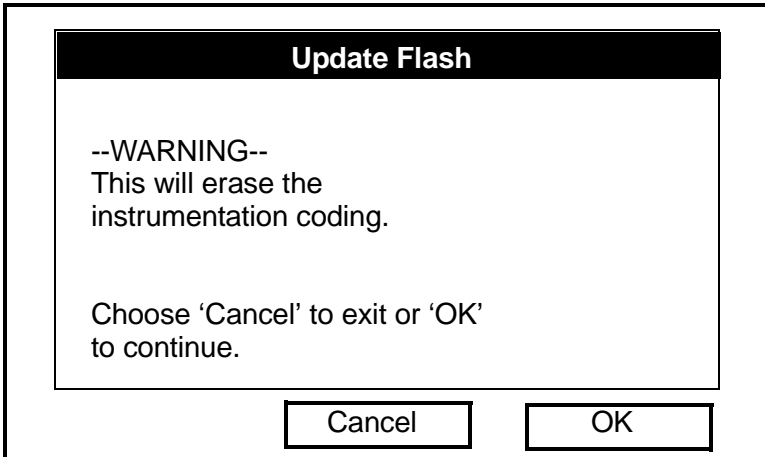

Figure 8-26: The Flash Update Window

- Press [F2] (Cancel) to return to Operate Mode without erasing the program.
 - Press [F3] (OK) to confirm that you wish to erase the program.
4. The meter asks for confirmation. Repeat the options shown in Step 1 above. After the PT878 reboots, the screen appears similar to Figure 8-27 below.

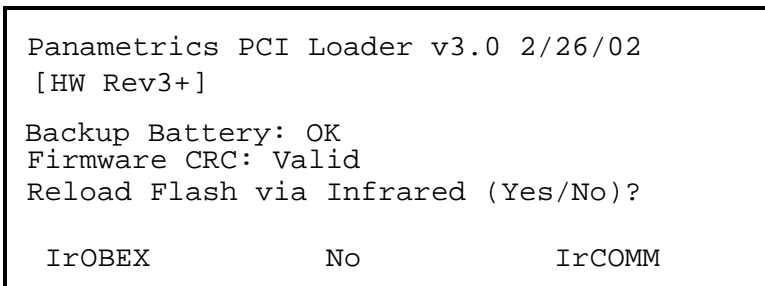

Figure 8-27: Flash Reloading Window

Updating Software Via IrOBEX (cont.)

5. The meter now asks if you wish to reload the flash memory via the infrared communications port.
 - Press [F1] (Yes) to begin reloading via OBEX, or
 - Press [F2] (No) to stop the reloading procedure.

Be sure the infrared sensor on the meter has a clear path to the infrared adapter on the PC. Now return to the PC.

6. You now have two options:
 - In Windows Explorer, browse to the file you wish to send. Select and right-click on it. Select *Send To* → *Infrared Recipient* or *Nearby Computer* (or *QuickBeam* if QuickBeam has been installed).
 - Open the *Infrared Transfer Application (My Computer\Infrared Recipient)*, click on *Send Files*, and select the files you wish to send.

In either case, a window displays the status of the file upload.

Updating Software Via IrCOMM

Note: *While Windows 95/98/98SE and NT (with QuickBeam) support IrCOMM, Windows 2000 and XP do not. Refer to Appendix F.*

Before you install new coding, you must be sure that the PC has the correct protocols to transmit the software to the meter.

Setting up the PC

Note: *The use of Hyperterminal is shown here as an example. If you are using a different communications software, see its manual for detailed instructions.*

1. From the Start Menu, click *Programs/Accessories/Hyperterminal* to open the Hyperterminal window.
2. If the call is not connected, click on *Connect* from the Call menu in Hyperterminal.
3. From the File menu, click *Properties*. Be sure the *New Connection Properties* window is set to your virtual infrared port.

Note: *You can determine which virtual port your infrared is using by opening Infrared Monitor in the Control Panel and clicking on the Options tab. It displays the message, "Providing Application Support on:" and then lists the virtual infrared port, as shown in Figure 8-28 on the next page.*

Setting up the PC (cont.)

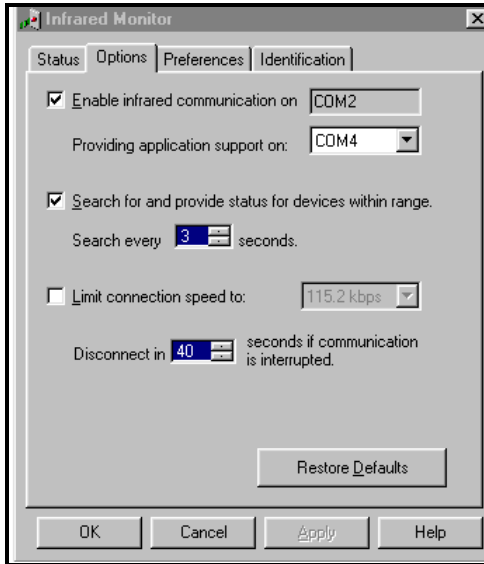

Figure 8-28: Port Settings for COMM 4

Installing New Software

To begin the loading procedure, scroll down to the Flash Update entry in the Service Menu and press [ENTER]. The screen appears similar to Figure 8-29 below.

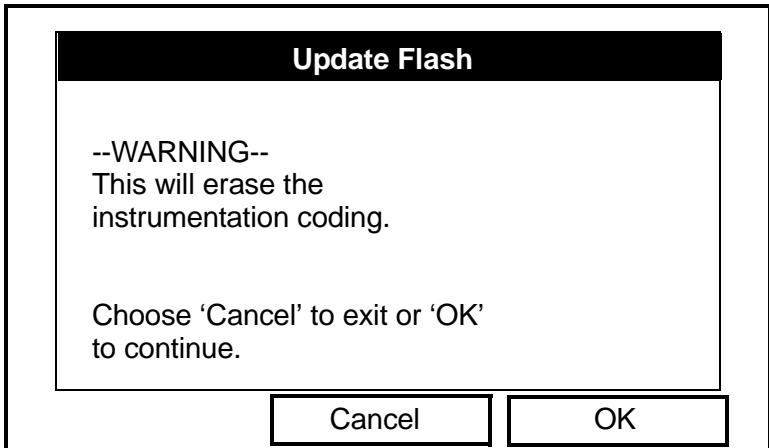

Figure 8-29: The Flash Update Option

Installing New Software (cont.)

1. As shown in Figure 8-29 on the previous page, the Flash Update option erases all instrument coding.
 - Press [F2] (Cancel) to return to Operate Mode without erasing the program.
 - Press [F3] (OK) to confirm that you wish to erase the program.
2. The meter asks for confirmation. Repeat the options shown in Step 1 above. The screen on both the PC and the PT878 now appears similar to Figure 8-30 below.

```

GE Infrastructure Sensing PCI Loader
v3.0 2/26/03 [HW Rev3+]

Backup Battery: OK
Firmware CRC: Valid
Reload Flash via Infrared (Yes/No)?

IrOBEX                No                IrCOMM
```

Figure 8-30: Flash Reloading Window

3. The meter now asks if you wish to reload the flash memory via the infrared communications port.
 - Press [F3] (Yes) (or C on the PC keyboard) to begin reloading via IrCOMM, or
 - Press [F2] (No) (or ESC on the keyboard) to stop the reloading procedure.
4. Be sure the infrared sensor on the meter has a clear path to the infrared adapter on the PC, and return to the PC Hyperterminal program.

Installing New Software (cont.)

1. In the Hyperterminal window, pull down the Transfer menu and click *Send File*. A window opens similar to Figure 8-31 below.

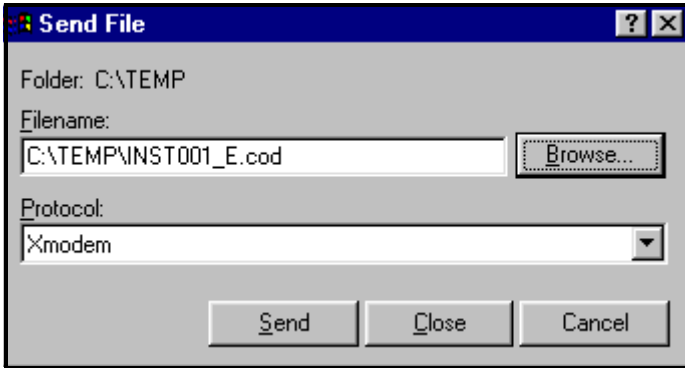

Figure 8-31: The Send File Window in the Transfer Menu

2. Click on the replacement software (designated by a .cod extension) from the folder where it has been stored.
3. From the Protocol drop-down menu, select Xmodem.
4. Click *Send*. For a successful transfer, the PC window appears similar to Figure 8-32 below, while the PT878 screen displays the program ID, size, load address and a count of blocks being loaded.

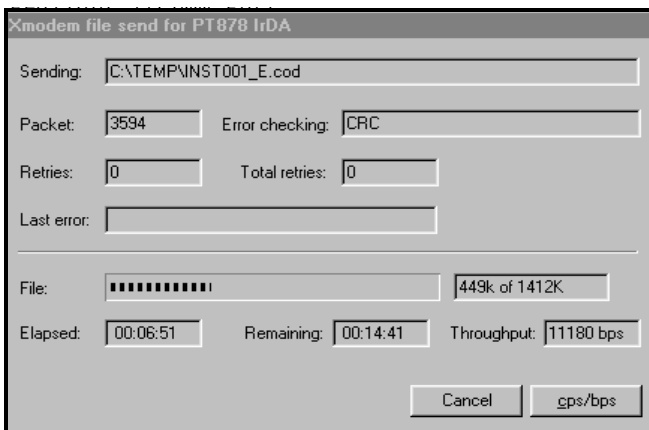

Figure 8-32: The File Transmission Window

Chapter 9

Diagnostics and Troubleshooting

The TransPort is a reliable instrument that is easy to maintain. It will provide accurate flow measurement readings as long as it is operated as described in this manual. If problems do arise with the electronics, transducers or the flowcell, the TransPort displays an error message specifying the possible problem. The TransPort also has a set of diagnostic parameters to help you find and remedy the problem.

In general, troubleshooting may be necessary if the TransPort displays an error message, the flow readings are erratic, or you have other reasons to doubt the accuracy of readings (for example, readings do not agree with other flow measuring devices connected to the same process).

This section describes error messages, diagnostic parameters, and shows you how to isolate problems to one of the following areas:

- Electronics, including programmed values
- Flowcell, which includes the pipe and fluid
- Transducers and cables.

Error Code Messages

Error Code messages appear on the screen while you are displaying measurements. When logs appear in graph form, errors are indicated by a vertical gray bar at the point of error. When they appear in a spreadsheet format, errors are indicated by their number, in place of the measurement. The Error Code messages are only general descriptions of the possible problems. Use Table 9-1 on page 9-3 to isolate and remedy the problem. If you are unable to remedy the problem, contact GE Infrastructure Sensing.

Note: *We suggest that, in order to isolate the indicated problem more easily, you obtain a test flowcell. Contact GE Infrastructure Sensing for details.*

Table 9-1: Error Messages

Error Message	Problem	Possible Cause	Action
E0	No error.	Displays briefly after the display of another error message	None required. Measurement is valid.
E1	Low Signal - Poor ultrasonic signal strength.	Broken cable. Flowcell problem. Transducer problem. Electronic failure.	Check transducer cable. See Flowcell Problems on page 9-8 and Transducer Problems on page 9-11. Check programming and transducer spacing. Contact the factory if problem persists.
E2	Sound Speed Error (Sound speed is programmed using the Program Menu Pipe option. as described in Chapter 5.)	Poor flow conditions. Incorrect programming. Bad transducer spacing. Measurement is very different from the programmed sound speed.	Check sound speed against nominal sound speed. See Flowcell Problems on page 9-8 and Transducer Problems on page 9-11. Check programming and transducer spacing.
E3	Velocity Range - Velocity exceeds programmed limits. (Velocity limit is programmed using the Service Menu Error Limits option as described in Chapter 8.)	Programming error, poor flow conditions, or bad transducer spacing.	Make sure flow rate is within ± 12 m/s (± 40 ft/s). Check programming and transducer spacing. If programmed value is outside of limit, change the limits as described in Chapter 8 on page 8-31 and 8-32. See Flowcell Problems on page 9-8 and Transducer Problems on page 9-11..

Table 9-1: Error Messages (Continued)

Error Message	Problem	Possible Cause	Action
E4	Signal Quality	If too high - electronic failure. If too low - flowcell, electrical problem.	Check for source of electrical interference. Check electronics with a test flowcell. If unit still fails to operate, contact the factory
E5	Amplitude Error	Excessive particles or bubbles present in fluid. A lot of second phase present	See Flowcell Problems on page 9-8.
E6	Cycle skip, Acceleration	Poor flow conditions or bad transducer spacing.	Check transducer spacing as programmed and as set on pipe. See Flowcell Problems on page 9-8 and Transducer Problems on page 9-11.
E7	Analog Out Error	Under current output.	Check that output load is within specification <550 ohm.
E8	Temperature Input Supply	Supply temperature input out of range.	Check cable and transmitter.
E9	Temperature Input Return	Return temperature input out of range.	Check cable and transmitter.

Displaying Diagnostic Parameters

As part of its measurement menu, the PT878 offers a list of diagnostic parameters to aid in troubleshooting in the event of flowcell, transducer, or electrical problems. You can select any diagnostic parameter for display as a measurement as discussed in Chapter 5, *Displaying and Configuring Data*, on page 5-7. Table 9-2 below shows all the available diagnostic parameters and ranges.

Table 9-2: Diagnostic Parameters

Diagnostic Parameter	Displays	Good	Bad
ΔT	Displays Delta T, or the difference between the upstream and downstream transit times.	N/A	Continuous large fluctuations of 1 micro second or more.
Amplitude Up	Displays the value for the amplitude discriminator of the upstream transducer.	20-28	<20 or > 28
Amplitude Down	Displays the value for the amplitude discriminator of the downstream transducer.	20-28 fluctuations	< 20 or > 28 fluctuations
T Up	Displays the upstream transit time of the ultrasonic signal in micro seconds.	N/A	N/A
T Down	Displays the downstream transit time of the ultrasonic signal in micro seconds.	N/A	N/A
Gain/Up	Displays upstream gain in dB.	N/A	N/A
Gain/Dn	Displays downstream gain in dB.	N/A	N/A
Sound speed (m/s or f/s)	Displays the measured sound speed of the fluid.	Check the sound speed of fluid in <i>Sound Speeds and Pipe Size Data</i> .	
P#up	Displays signal peaks for the upstream transducer.	100-900	<100, >900

Table 9-2: Diagnostic Parameters (Continued)

Diagnostic Parameter	Displays	Good	Bad
P#dn	Displays signal peaks for the downstream transducer.	100-900	<100, >900
Reynolds #	Displays the Reynolds Number.	N/A	N/A
K(RE)	Displays the K Factor, based on the Reynolds Number.	N/A	N/A
Raw Up	Displays raw upstream signal.	N/A	N/A
Raw Down	Displays raw downstream signal.	N/A	N/A
Xmit Corr Up	Displays raw upstream signal correlated with transmit signal.	N/A	N/A
Xmit Corr Dn	Displays raw downstream signal correlated with transmit signal.	N/A	N/A
Cross Corr	Displays transmit upstream signal correlated with transmit downstream signal.	N/A	N/A
SS up	Displays the signal strength for the upstream transducer.	50-80	<50
SS do	Displays the signal strength for the downstream transducer.	50-80	<50
PEAK%	Displays the Percent of Peak. Set to -40 by default. To change see Chapter 8, page 8-25.	N/A	N/A
Qup	Displays the signal quality for the upstream transducer.	±300 or higher	between ±100
Qdown	Displays the signal quality for the downstream transducer.	±300 or higher	between ±100
NFup	Displays the normalization factor for the upstream transducer.	0.85 - 1.0	<0.85
NFdn	Displays the normalization factor for the downstream transducer.	0.85 - 1.0	<0.85

Table 9-2: Diagnostic Parameters (Continued)

Diagnostic Parameter	Displays	Good	Bad
TEMPs	Displays the temperature for the supply input (energy measurement).	N/A	N/A
TEMPr	Displays the temperature for the return input (energy measurement).	N/A	N/A
Ts - Tr	Displays the difference between the temperature for the supply input and the temperature for the return input (energy measurement).	N/A	N/A
DENSs	Displays the density for the supply input. (Energy measurement.)	N/A	N/A
DENSr	Displays the density for the return input. (Energy measurement.)	N/A	N/A
DELTh	Displays the delta enthalpy, or difference between the supply and return enthalpy (enthalpy is a measure of energy contained in the fluid.) (Energy measurement.)	N/A	N/A

Flowcell Problems

Flowcell problems fall into two categories: fluid problems and pipe problems. Read the following sections carefully to determine if such problems exist.

Fluid Problems

Most fluid-related problems can be solved by proper design of the flowmeter installation and the proper choice of transducer frequency. Contact GE Infrastructure Sensing if you cannot solve a fluid-related problem.

Certain fluid properties may prevent proper flow measurement. Some fluid properties that cause problems are listed below.

- 1. THE FLUID MUST BE HOMOGENOUS, SINGLE PHASE, RELATIVELY CLEAN, and FLOWING STEADILY.** Solid particles and gas bubbles absorb and disperse ultrasound. Although, in some cases, solids and gases have little effect on the operation of the TransPort, excessive amounts will prevent ultrasound transmission through the fluid and interfere with proper flow measurement. Temperature gradients may also cause a problem.
- 2. THE FLUID MUST NOT CAVITATE NEAR THE FLOWCELL.** Fluids with a high vapor pressure may cavitate near or in the flowcell. This causes problems resulting from gas bubbles in the fluid. Cavitation can usually be controlled through proper installation design.
- 3. THE FLUID MUST NOT ATTENUATE ULTRASOUND EXCESSIVELY.** Some fluids, particularly those that are very viscous, absorb ultrasound energy. In these cases an “E1” will display on the screen to indicate that the ultrasonic signal is not of sufficient strength for reliable measurements.

Fluid Problems (cont.)

- 4. THE FLUID SOUND SPEED MUST NOT VARY EXCESSIVELY.** The TransPort will tolerate relatively wide, but slow, changes in fluid sound speed due to changes in fluid composition and temperature. However, if you are measuring a fluid that is considerably different from the fluid programmed into the TransPort, you may have to adjust the meter for the new fluid. Refer to Chapter 3, *Programming Site Data*, on page 3-13.

Pipe Problems

Improper pipe conditions and/or flowcell installation can cause problems with measurement of the fluid flow. Check the items below if you suspect this class of problem. Contact GE Infrastructure Sensing if you cannot solve pipe-related problems.

- 1. THE INSIDE OF THE PIPE OR FLOWCELL MUST BE RELATIVELY CLEAN.** Excessive build up of scale, rust, or debris will interfere with flow measurement. Generally, a thin coating or a solid well-adhered buildup on the pipe wall will not cause problems. Loose scale and thick coatings (such as tar or oil) will interfere with ultrasound transmission and may result in incorrect or unreliable measurements.
- 2. THE FLOWCELL ORIENTATION MUST NOT ALLOW SEDIMENT OR GAS ENTRAPMENT AT THE TRANSDUCER LOCATIONS.** Sediment or gas trapped in the transducer ports for wetted transducers, or at the transducer locations for clamp-on transducers, will interfere with flow measurement. Realignment of the flowcell or transducers often cures these problems. In some cases different transducers may be used that protrude into the flow stream.

Pipe Problems (cont.)

- 3. THE PIPE OR FLOWCELL DIMENSIONS MUST BE ACCURATE.** The accuracy of your flow measurements will be no better than the accuracy of your programmed pipe or flowcell dimensions. If GE Infrastructure Sensing did not supply your flow cell, the dimensions you program must be consistent with the required flow accuracy. Check your pipe for wall thickness, diameter, dents, eccentricity, weld deformity, and straightness.
- 4. THE PIPE SURFACES SHOULD BE SMOOTH (FOR CLAMP-ON).** When using clamp-on transducers, both the inside and the outside of the pipe at the transducer locations must be smooth. If the pipe is extremely rough, the ultrasonic signal will be scattered by the rough surface, and will not be received by the flowmeter, preventing flow measurement.
- 5. THE PIPE MUST ALLOW ULTRASOUND TO PASS THROUGH (FOR CLAMP-ON).** Some pipe materials or linings such as Fiberglass (or generic fiber reinforced pipe), Teflon, and polyethylene, absorb ultrasound and may cause problems in clamp-on applications. Pipes with extremely thick walls or high OD to ID ratios may also present difficulties.

Transducer Problems

Ultrasonic transducers are rugged. However, they are subject to physical damage due to mishandling and chemical attack. Clamp-on transducers are also subject to installation variables such as physical misalignment and faulty coupling to the pipe on which they are mounted.

Because transducer problems are largely dependent on the type of transducer used, wetted or clamp-on, the following list of potential problems is grouped according to transducer type. Contact GE Infrastructure Sensing if you cannot solve a transducer-related problem.

Wetted Transducer Problems

1. LEAKS

Leaks may occur around the transducer and in the fittings of the flow cell. Repair as you would any other leak. Check the transducer and cables for damage if the leaking fluid is corrosive.

2. CORROSION DAMAGE

Wetted transducers may be damaged by corrosive fluids if the transducer material does not match the application. Most often, corrosion damage occurs at the electrical connector. To check for damage, remove the transducer from the flow cell. If the wetted end of the transducer is rough and pitted, the transducer may have to be replaced. GE Infrastructure Sensing can supply suitable transducer materials for most fluids. Contact GE Infrastructure Sensing for information on special transducers.

Wetted Transducer Problems (cont.)

3. INTERNAL DAMAGE

An ultrasonic transducer consists of a ceramic “crystal” bonded to the transducer case. The bond between the crystal and the case may be damaged by extreme mechanical shock and by temperature extremes. The crystal itself can also be damaged by the same conditions. The internal wiring can be corroded or shorted if contaminants enter the transducer housing.

4. PHYSICAL DAMAGE

Transducers may be physically damaged by dropping them onto a hard surface or striking them against another object. Usually the connector on the transducer is the part that is damaged, as it is the most fragile. Minor damage may be repaired by carefully bending the connector back into shape. If the connector cannot be repaired, replace the transducers. Note that transducers must be replaced in pairs. Before replacement, make sure that the transducer number in the programmed parameters is the one engraved on the new transducers (see Chapter 3, *Programming Site Data*).

Clamp-on Transducer Problems

1. POOR COUPLING TO PIPE

Clamp-on transducers must be in intimate contact with the pipe. The pipe wall must be smooth and generally free of paint. The couplant material must fill voids between the transducer and the pipe, and must be firmly coupled or bonded to both the pipe and the transducer. The pipe and transducer must be clean and dry for permanent couplant, such as grease or epoxy, to adhere properly. Enough pressure must be applied to the transducer by its clamp to hold it firmly against the pipe.

Clamp-on Transducer Problems (cont.)

2. MISALIGNMENT

The transducer transmits relatively narrow beams of ultrasound, and therefore transducer alignment is critical to assure that the beam can travel from one transducer to the other without undue attenuation. Be sure to exactly follow the instructions that came with your transducers and clamping fixtures. Also, be sure that the transducer spacing agrees with the calculated spacing (S).

3. INTERNAL DAMAGE

Ultrasonic transducers consist of a ceramic “crystal” bonded to the transducer case. The bond between the crystal and the case may be damaged by extreme shock and by temperature extremes. The crystal itself can also be damaged by the same conditions. The internal wiring can be corroded or shorted if contaminants enter the transducer housing.

4. PHYSICAL DAMAGE

Transducers may be physically damaged by dropping them onto a hard surface or striking them against another object. Usually the connector on the transducer is the part that is damaged, as it is the most fragile. Minor damage may be repaired by carefully bending the connector back into shape. If the connector cannot be repaired, replace the transducers. Note that transducers must be replaced in pairs, and that after replacement the flowmeter parameters should be checked (see Chapter 3, *Programming Site Data*).

5. CYCLE SKIP CONDITION

A cycle skip is usually caused by a distorted or altered signal due to poor couplant, bad wall, or unusual fluid disturbances. To resolve a cycle skip, recouple both transducers with proper couplant. Try standard CPL-1 couplant that is good to 212°F (100°C) or CPL-2 for up to 500°F (260°C). In addition, make sure the pipe wall is free of paint and rust.

Contact GE Infrastructure Sensing if you cannot solve a transducer-related problem.

Relocating Transducers

If the coupling or pipe wall are not the problem, try relocating the transducers using the following method. However, before beginning, make sure the transducers are not located on or near pipe welds or seams:

Move one transducer about 1/2 inch (12.7 mm) closer to the other transducer. If this resolves the problem, you must modify the “S” dimension programmed into the PT878 by using the following steps:

1. Press [MENU].
2. Scroll to the Program menu and press [ENTER].
3. Scroll to the Path option and press [ENTER]. Then scroll down to the Spacing box and press [ENTER].
4. Use the numeric keys to enter the transducer spacing. Subtract 0.5 in. (12.7 mm) from the original “S” and enter the new “S” dimension.
5. Press [F3] (OK).

If this method does not resolve the problem, contact GE Infrastructure Sensing.

Chapter 10

Specifications

This section contains specifications for the following:

- Overall
- Electrical
- Transducer
- Fluid Types
- Pipe Size and Materials
- Available Options

Overall

Hardware Configuration

Channel Options: Single channel

Mode Options: Transit-time

Size/Weight

Size without boot: 238 × 138 × 38 mm
(9.4 × 5.5 × 1.5 inches)

Weight with boot: 1.36 kg (3 lb)

Enclosure

Submersible, IP67

Flow Accuracy (Velocity, % of reading):

Clamp-on Transducers: **Pipe Diameter > 150 mm (6 in.)**

±1% to 2% of reading typical

Pipe Diameter ≤ 150 mm (6 in.)

±2 to 5% of reading typical

Note: *Accuracy depends on pipe size and whether measurement is one-path or two-path. Accuracy to ±0.5% of reading may be achievable with process calibration.*

Range: -12.2 to 12.2 m/s (-40 to 40 ft/s)

Rangeability: 400:1

Repeatability: ±0.1% to 0.3% of reading

Note: *Specifications assume a fully developed flow profile (typically 10 diameters upstream and 5 diameters downstream of straight pipe run) and flow velocity greater than 1 ft/s (0.3 m/s).*

Energy Accuracy (% of reading): The accuracy of the energy measurement is a combination of the accuracy of the flow and temperature measurement. Accuracy of 1% is typical for calibrated systems.

Overall (cont.)

Low Voltage
Directive
Compliance:

This unit complies with European
Standard EN61010-1 Installation
Category II, Pollution Degree 2.

EMC
Directive
Compliance

This unit complies with EN61326:1998
CL.A Annex C. For continuous
unmonitored operation, follow
provisions of the 89/336/EMC
Compliance.

Electrical

Internal Batteries

- Type: Rechargeable batteries. (Optional NiCad 6_R nonrechargeable alkaline available.)
- Battery Life: 9-11 hours of continuous operation is typical

Battery Charger:

- Input: 100-250 VAC, 50/60 Hz, 0.38 A
- Memory: 1 MB datalog/site battery-backed RAM
1 MB program FLASH memory

Environmental:

- Operating Temperature: -20 to 55°C (-4 to 131° F)
- Storage Temperature: -40 to 70°C (-40 to 158° F)

Note: *To ensure maximum battery life storage, do not exceed 35 °C (95° F) for long periods.*

Operating Modes

- Flow Measurement: Transit-Time™ mode with clamp-on or wetted transducers
- Energy: To calculate energy flow rate, use the external loop-powered RTD transmitter (Part # 2CHRT)

Electrical (cont.)

Input/Output

Keypad:	25-key rubberized tactile membrane keypad
Display:	240 × 200 pixel LCD graphic display with EL backlight
Printer/Terminal:	Infrared communications port
Analog Output:	One 4-20 mA or 0-20 mA current output
Digital Output:	One user-selectable pulse (solid-state, 5-V maximum) or frequency (5-V square wave, 100 to 10,000 Hz)
Analog Input:	Two 4-20 mA analog inputs with switchable 16 V supply for loop-powered temperature transmitters
Acoustic:	One pair of LEMO [®] coaxial transducer connectors
Cable and length:	Cable length 8 m (25 ft) standard. Up to 305 m (1000 ft) optional with extension cables.

Operational Specifications

Site Parameter Programming:	Menu-driven operator interface using a keypad and “soft” function keys. On-line help functions including pipe tables. Storage for saving parameters for up to 64 sites.
Data Logging:	Memory capacity to log over 100,000 flow data points. Keypad programmable for log units, update times and start and stop times.
Display Functions:	Graphic displays shows flow in numeric or graphical format. Also displays logged data. Supports multiple languages: English, French, German, Japanese, Spanish (Castilian and South American), Italian, Portuguese, Dutch, Russian and Swedish.
Totalizers:	Pulse or frequency totalizer output.

Transducer

Clamp-On Ultrasonic Flow Transducers

Temperature Range:

Standard: -40 to 60° C (-40 to 140° F)

Optional (overall): -190° to 300°C (-310° to 572°F)

Housing:

Standard: None

Optional: List models or consult factory:
Environmental, flameproof and
explosion-proof styles available.

Mounting: SS Chain or strap, welded or magnetic
clamping fixtures

Temperature Transducers

Types: Loop-powered 3-wire platinum RTD's;
clamp-on and wetted (thermowell) types
are available.

Accuracy: 0.15°C wetted RTD's (matched pairs)

Range: -20 to 260°C (-4 to 500°F)

Pipe Size and Material

Clamp-On Transducers:

Materials: All metals, most plastics; consult GE Infrastructure Sensing for concrete, composite materials and highly corroded or lined pipes

Pipe Sizes: 12.7 mm to 7.6 m outside (OD)
(0.5 to 300 in.)

Pipe Wall Thickness: Up to 75 mm (3 in.)

Available Options

Thickness Measuring Mode

Standard Transducer:	GE Infrastructure Sensing dual element transducer
Pipe Thickness Range:	1.3 to 76.2 mm (0.05 to 3.0 in.)
Pipe Materials:	Most standard metal and plastic pipe materials
Accuracy:	±1% typical or ±0.05 mm (±0.002 in.)
Display Resolution:	0.01 mm (0.001 in.)
Thermal Exposure:	Continuous operation to 37°C (100°F) Intermittent operation to 260° C (500° F) for 10 seconds followed by air cooling for 2 minutes.

Energy Equipment

Dual RTD transmitter; two 4 to 20-mA transmitters with input for 3-wire RTD (100 Ω Pt) and terminals for 4 to 20-mA output; and 6-ft. cable

PC Option

Infrared adapter plugs into any available serial port to give desktop PCs infrared capability

Printer Option

Thermal printer with rechargeable battery and 120 to 240-VAC power supply/recharger

PC Interface Software

PanaView™ Instrument Interface Software

Appendix A

Menu Maps

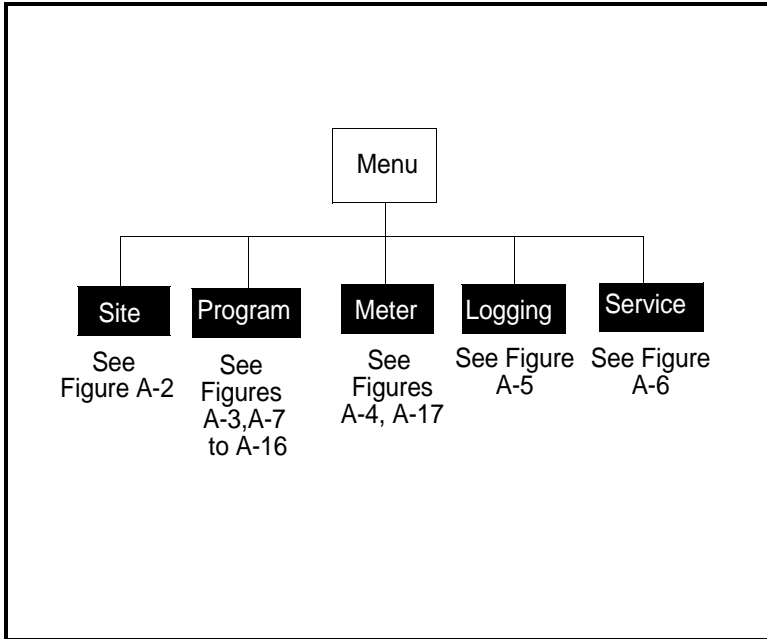
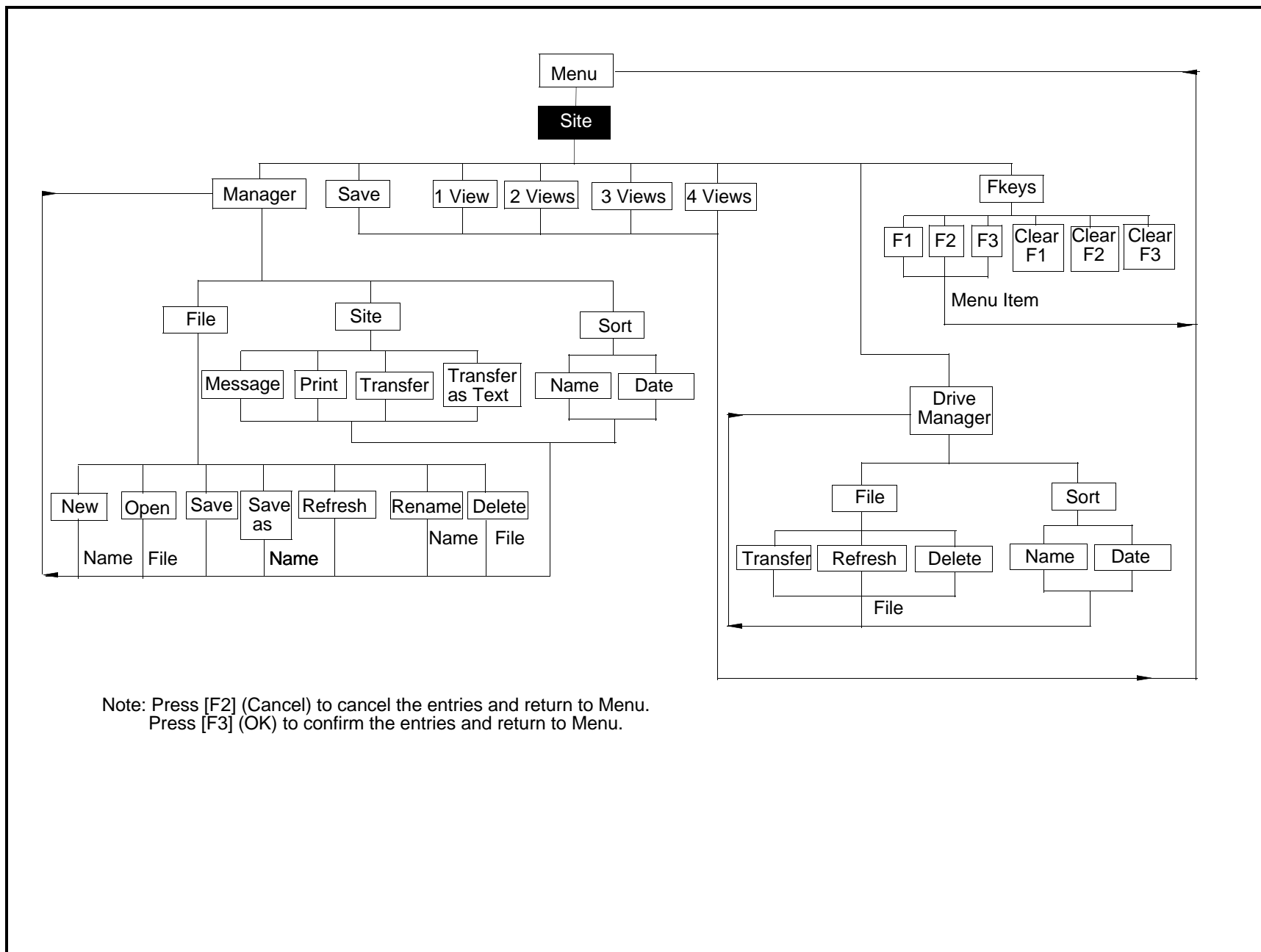

Figure A-1: The Main Menu



Note: Press [F2] (Cancel) to cancel the entries and return to Menu.
 Press [F3] (OK) to confirm the entries and return to Menu.

Figure A-2: The Site Menu

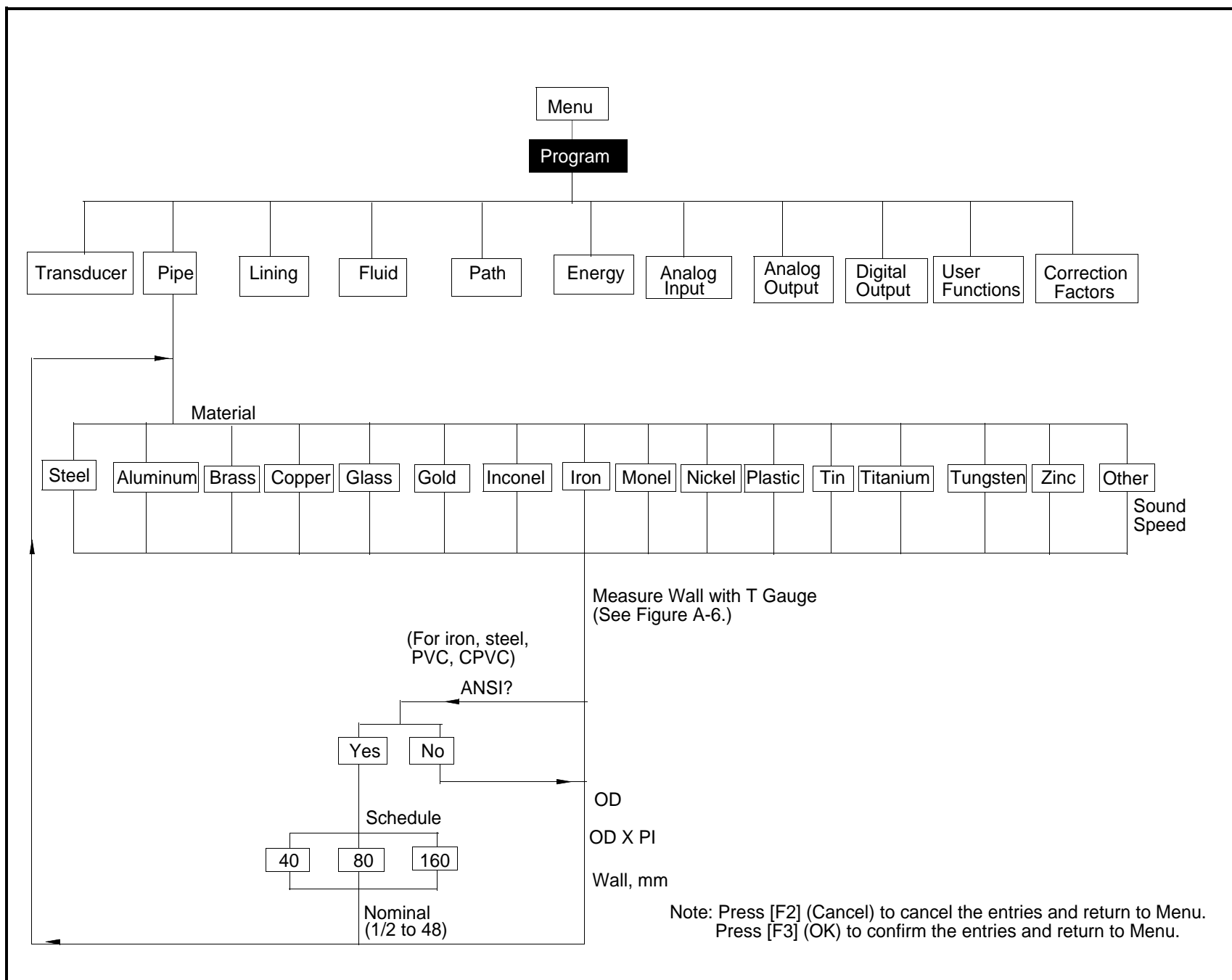

Figure A-3: The Program Menu with Pipe Option

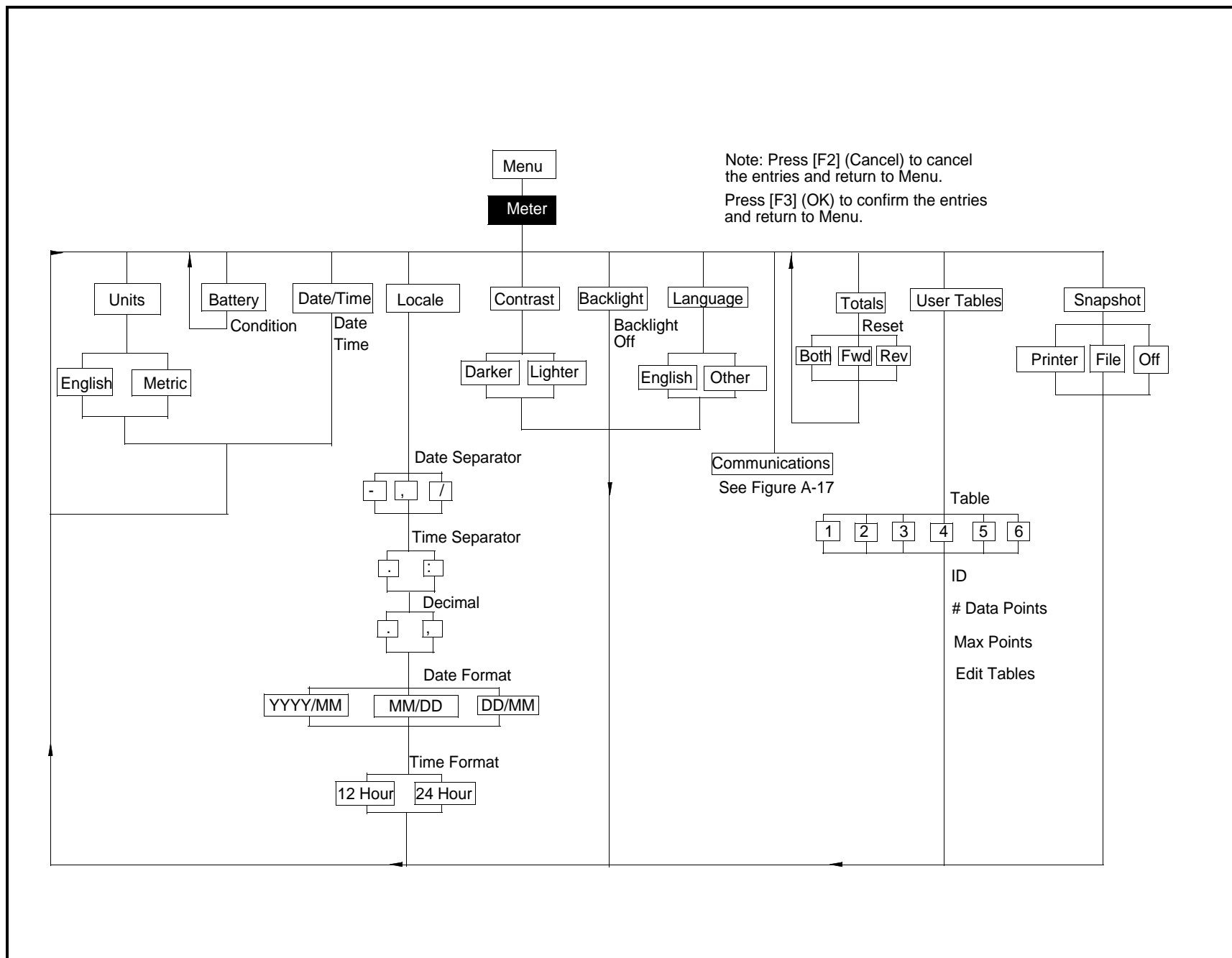

Figure A-4: The Meter Menu

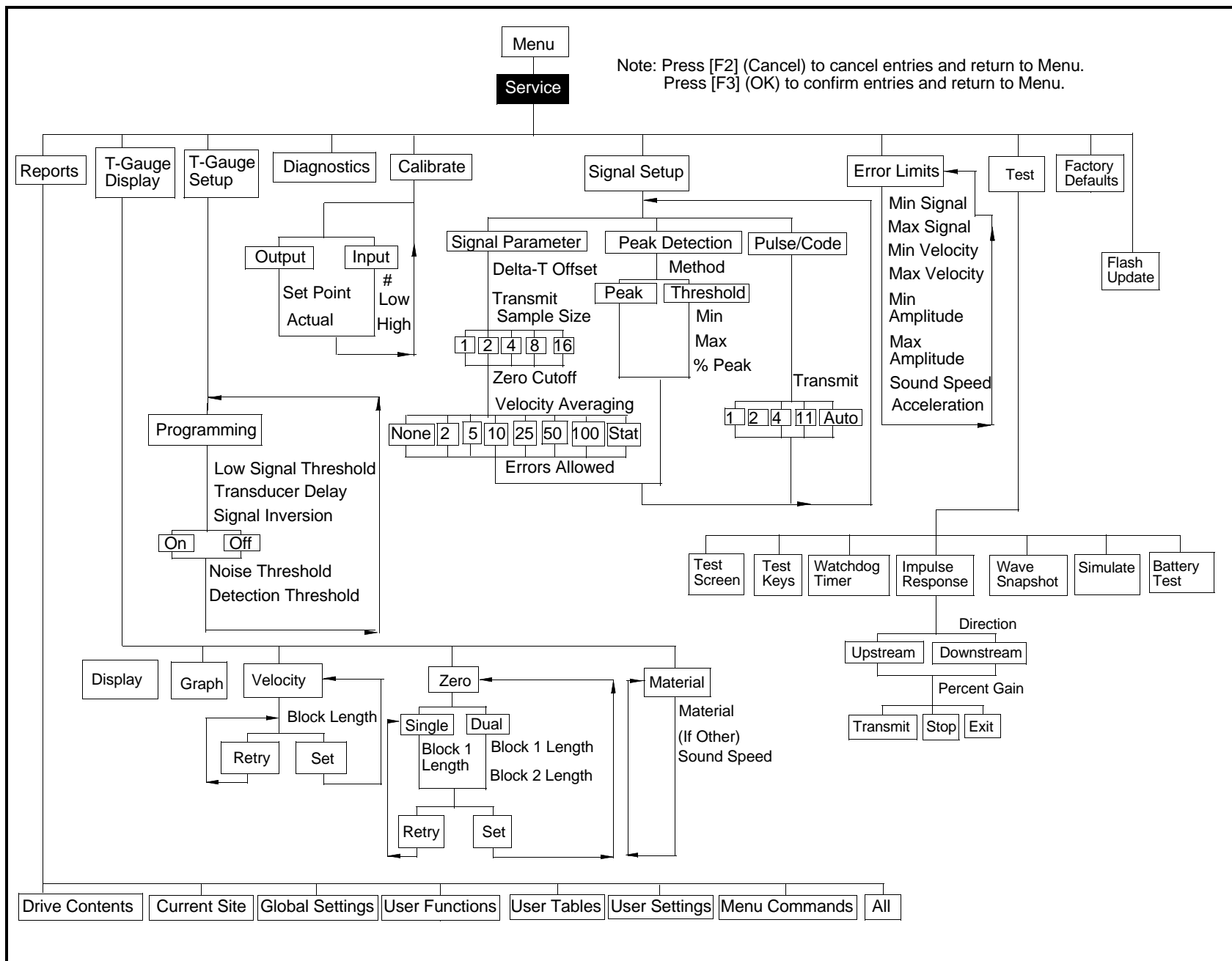

Figure A-6: The Service Menu

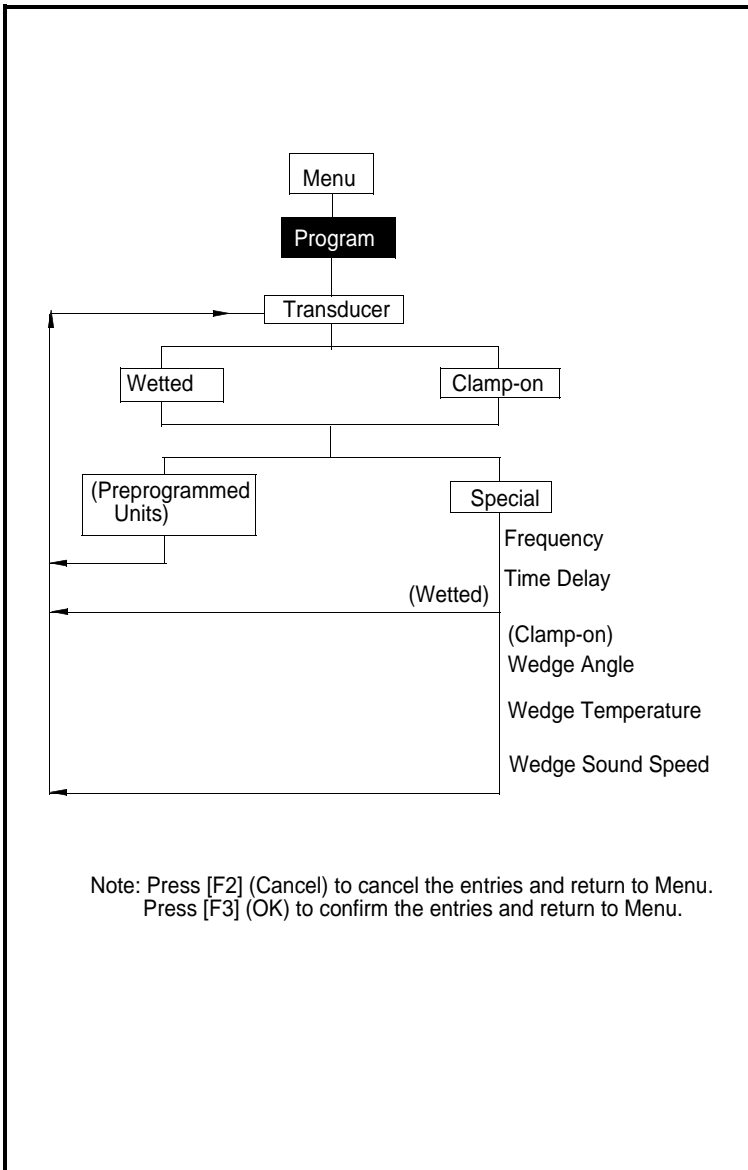
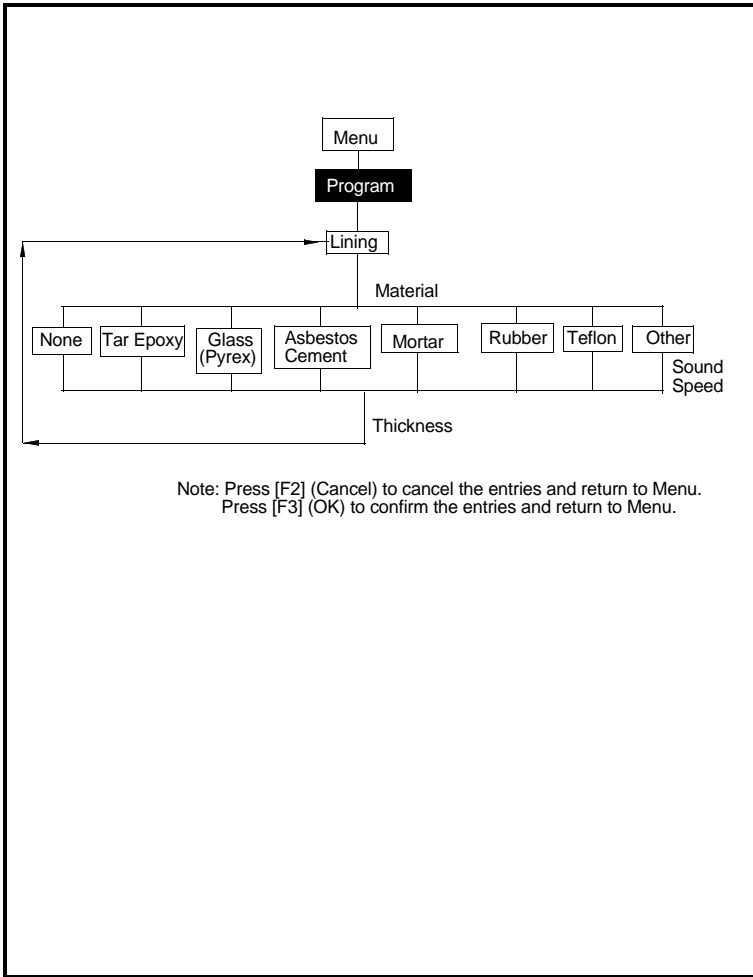

Figure A-7: The Transducer Option



Note: Press [F2] (Cancel) to cancel the entries and return to Menu.
Press [F3] (OK) to confirm the entries and return to Menu.

Figure A-8: The Lining Option

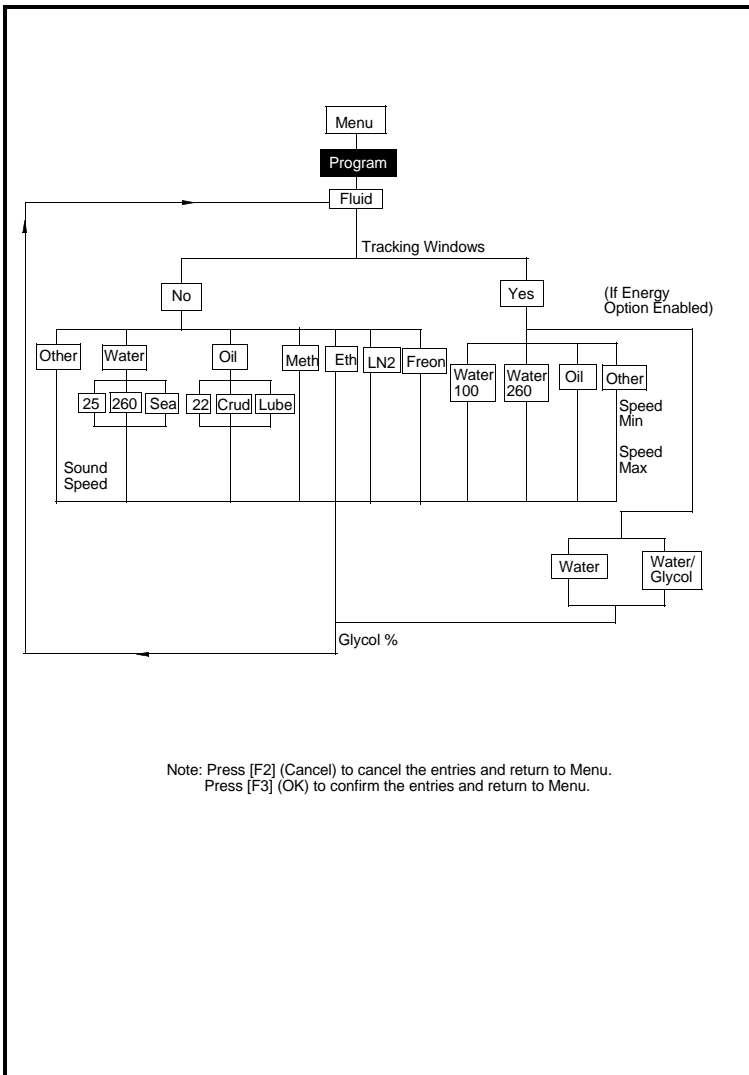

Figure A-9: The Fluid Option

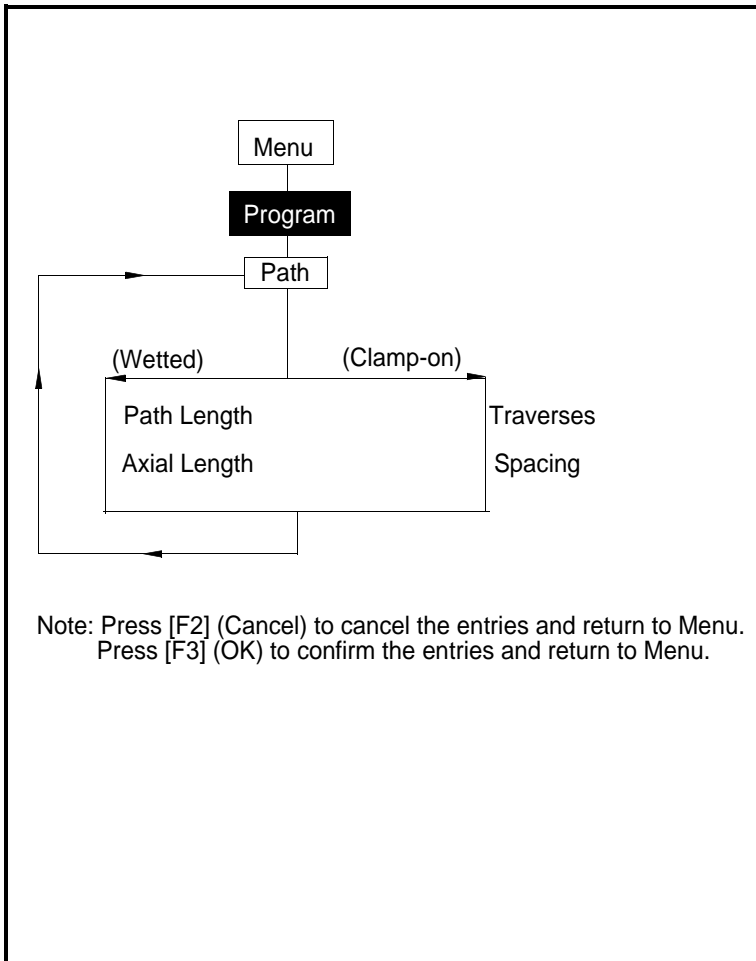

Figure A-10: The Path Option

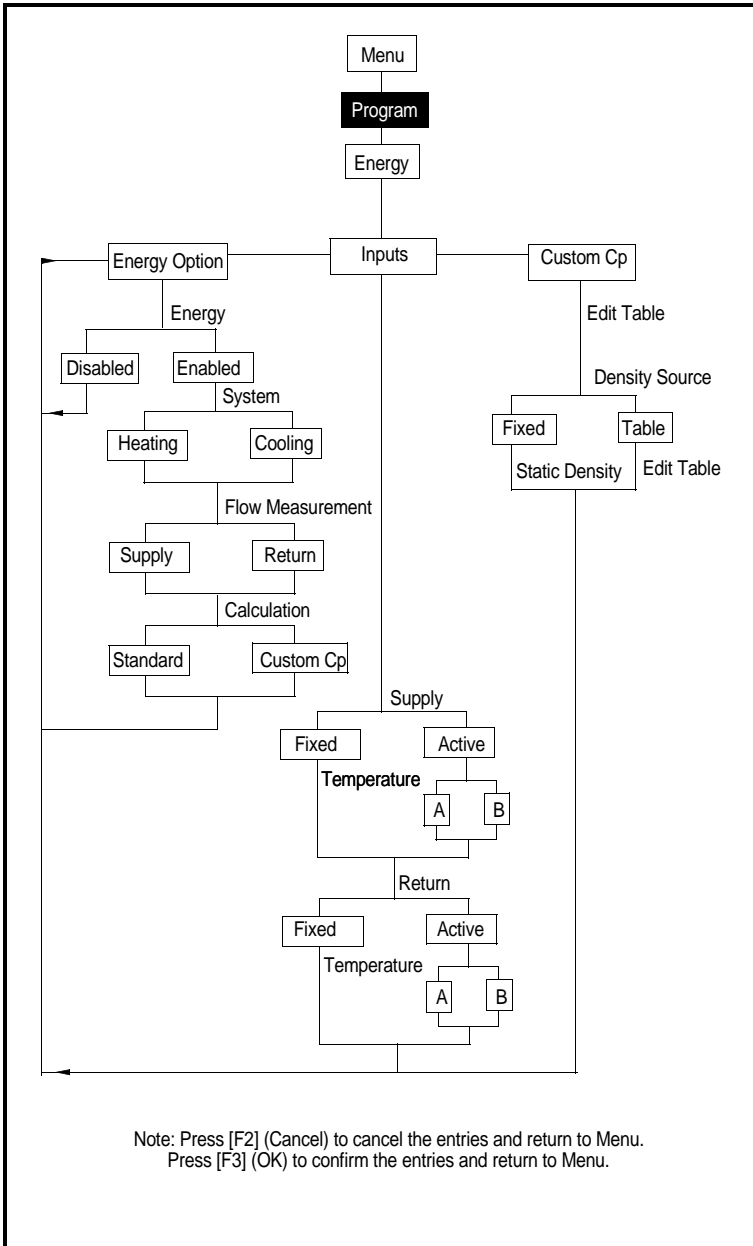

Figure A-11: The Energy Option

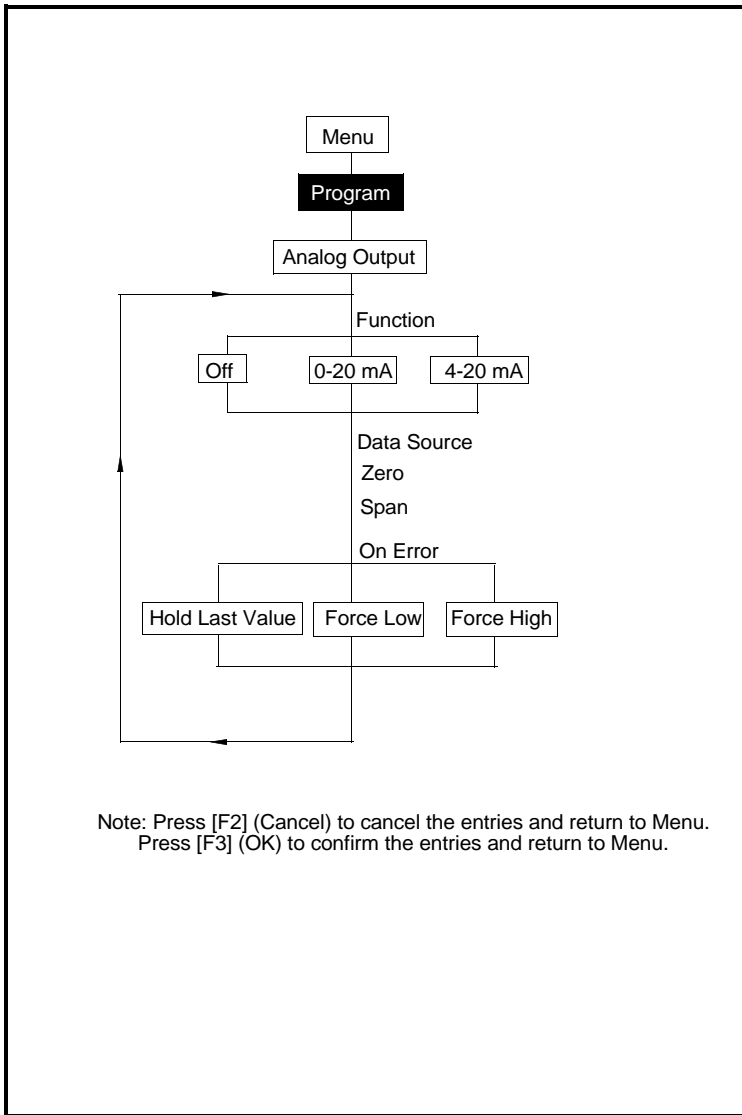
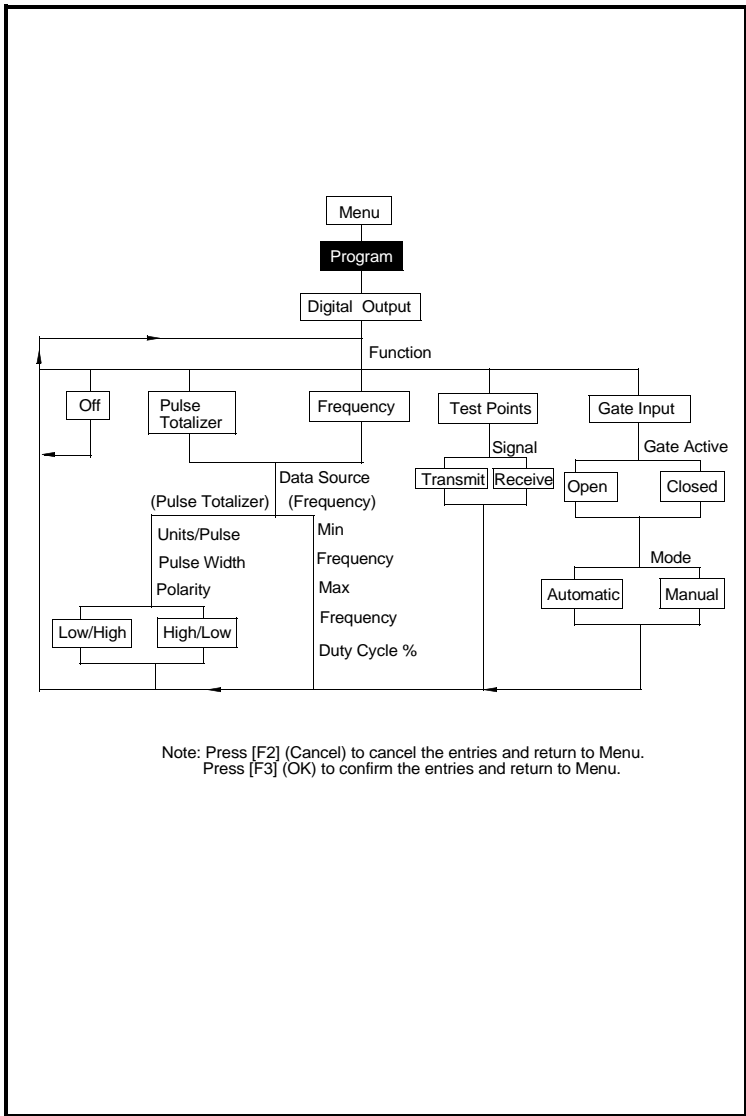
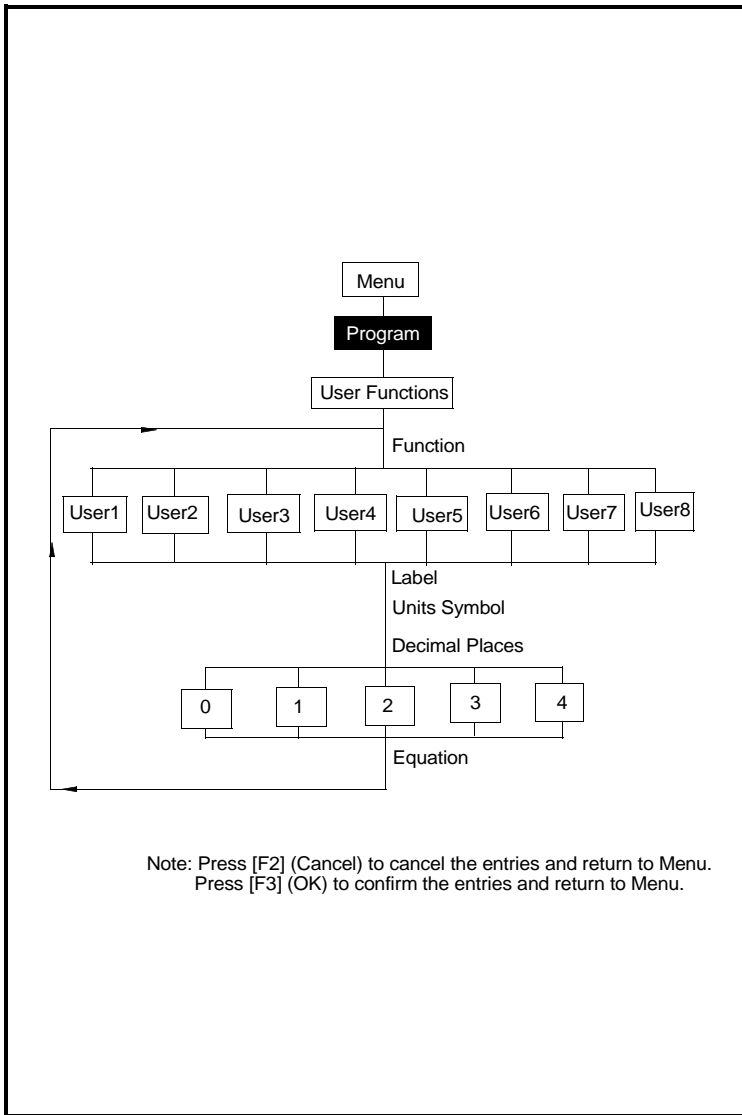

Figure A-13: The Analog Output Option



Note: Press [F2] (Cancel) to cancel the entries and return to Menu.
Press [F3] (OK) to confirm the entries and return to Menu.

Figure A-14: The Digital Output Option



Note: Press [F2] (Cancel) to cancel the entries and return to Menu.
 Press [F3] (OK) to confirm the entries and return to Menu.

Figure A-15: The User Functions Option

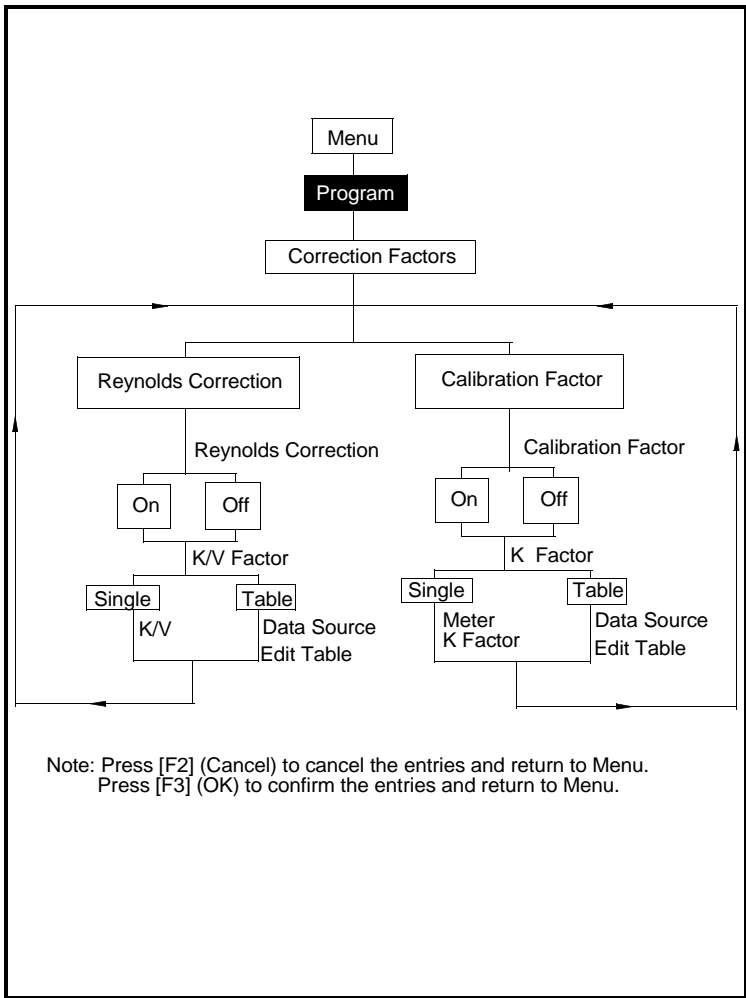

Figure A-16: The Correction Factors Option

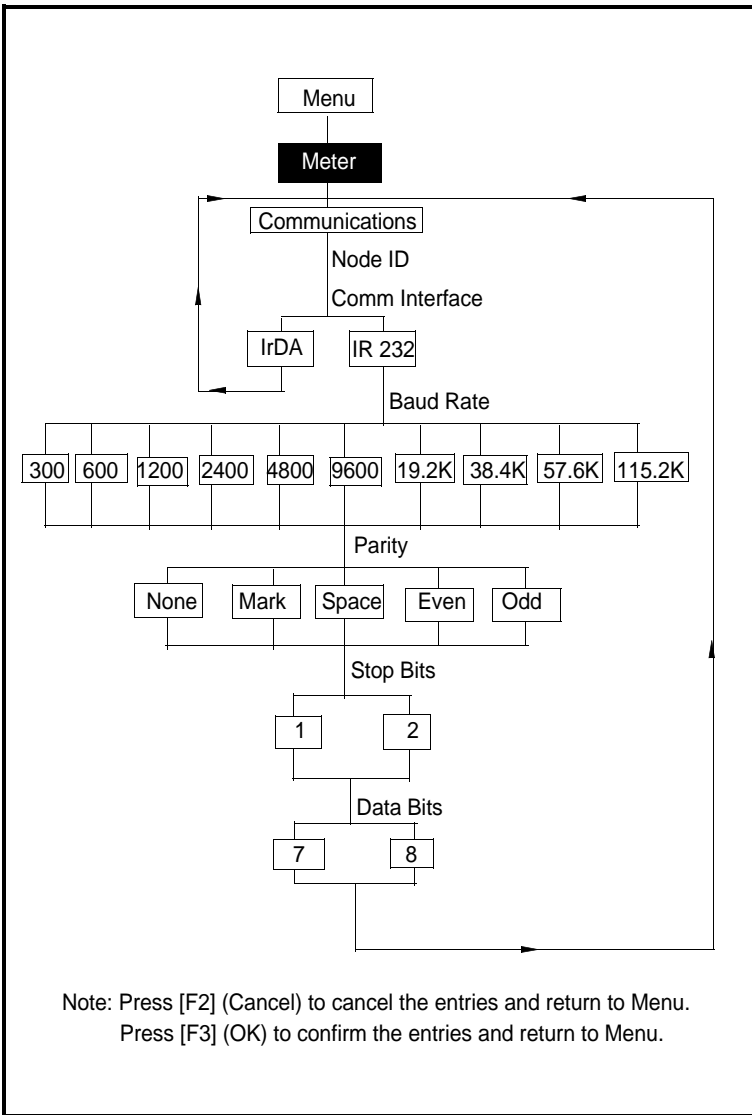

Figure A-17: The Communications Option

Appendix B

Measuring P and L Dimensions

If you are using wetted transducers, the PT878 requires you to enter the path length (P) and the axial dimension (L). P is the transducer face-to-face distance, and L is the axial projection of P in the flow stream.

To determine L , physically measure the distance between the center of the transducer ports at the inside wall as shown in Figure B-1 below, if possible. If not, consult the factory.

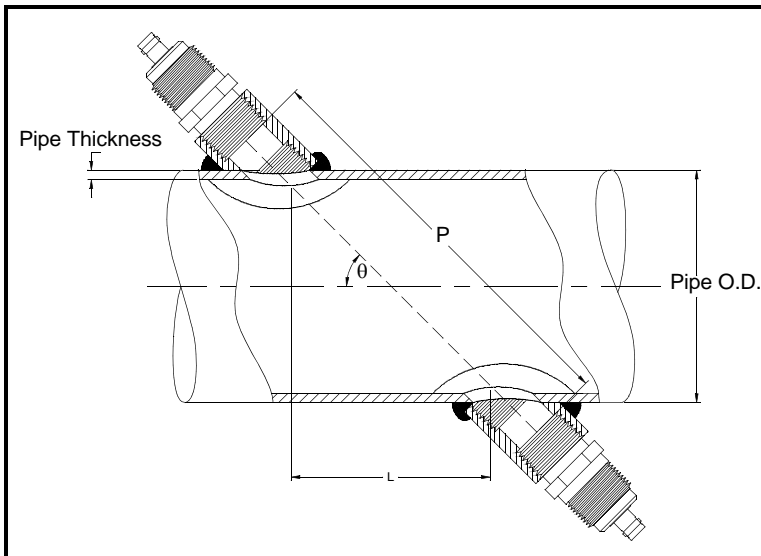

Figure B-1: Top View of 180° Transducer Installation

Measuring P and L Dimensions (cont.)

To determine P, you need the following:

- the pipe inside diameter (ID)
- the wall thickness (WT)
- the installed pipe coupling length (CL)
- the transducers face depth (FD)
- the mounting angle (MA)

Use Figure B-2 below to properly measure the coupling length. Typically, the transducer face is positioned just outside the inside diameter (ID) of the pipe, or slightly retracted inside the coupling.

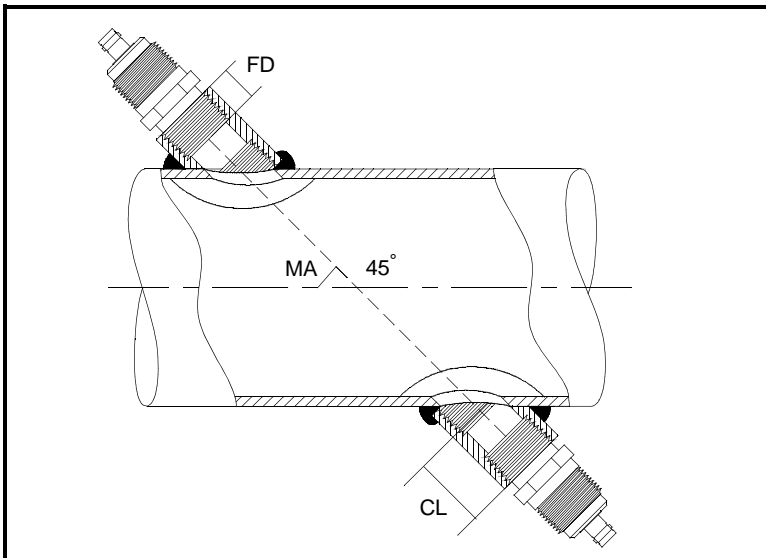

Figure B-2: Determining the Pipe Coupling Length

Measuring P and L Dimensions (cont.)

Use the following formula to determine the P dimension:

$$[ID + 2(WT)]/(\cos MA) + 2 (CL- FD) = P \text{ dimension}$$

For example, given the following:

- inside diameter (ID) = 48”
- wall thickness (WT) = 3/8”
- installed coupling length (CL) = 2.0”
- a transducer face depth (FD) = 1.75”
- mounting angle (MA) = 45°

The P dimension would be:

$$[48 + 2(3/8)]/(0.7071) + 2(2.0-1.75) = 69.4”$$

Appendix C

Temperature Transmitter Installation

The PT878 requires a supply and return temperature input to measure energy rate and consumption. You must connect the temperature sensors to a 4 to 20 mA transmitter (powered by the PT878 or externally) and then from the transmitter to the PT878 (a special GE Infrastructure Sensing cable is required to make transmitter-to-PT878 connections).

GE Infrastructure Sensing can supply the Resistive Temperature Device (RTD) and a Dual Transmitter (DTR) or you may supply your own. If you supply your own equipment, you will need to order a special GE Infrastructure Sensing cable with a LEMO connector to make connections from the transmitter to the PT878.

To install the RTDs, you need to do the following:

- find a suitable installation site
- mount RTDs on the pipe
- make electrical connections

Use the instructions that follow to install the RTDs.

Guidelines for RTD Installation

You should have discussed possible installation sites with an applications engineer or field sales person by the time you receive the RTDs. However, you should follow these guidelines to ensure accurate temperature measurement:

- Do not install the RTD on a pipe seam.
- Clean the pipe at the installation location.
- Do not install the RTD on the top or the bottom of the pipe.
- Apply thermal couplant to the RTD before mounting it to the pipe.
- Insulate the pipe and RTD after installation.

If you have a GE Infrastructure Sensing RTD, use the instructions in the next section to properly mount the RTD on the pipe.

Mounting RTDs on the Pipe

GE Infrastructure Sensing supplies a clamping fixture to mount the RTDs to the pipe; however, you must assemble the clamping fixture before you can mount the RTDs to the pipe. Use the following instructions below to mount the RTDs.

Assembling the Clamping Fixture

The clamping fixture consists of the following parts:

- one strap (length depends on the pipe size)
- a screw buckle
- a feeder buckle

To assemble the clamping fixture:

1. Cut the strap equal to the circumference of the pipe.
2. Fold 1/2 inch of one end of the strap into a hook shape.

Assembling the Clamping Fixture (cont.)

3. Secure the screw buckle to one end of the strap by placing the strap through the buckle and folding the strap.
4. Crimp the strap closed to secure the screw buckle in place.
5. Each RTD has a securing post (located on the rounded portion of the RTD) that secures the RTD in place when it is mounted on the pipe. Place the RTD on the strap by sliding the strap under the securing post.

IMPORTANT: *Make sure you place the RTD on the strap so when the strap is wrapped around the pipe, the flat surface of the RTD sits against the pipe.*

6. Secure the feeder buckle to the other end of the strap by placing the strap through the buckle and folding the strap (the folded section should be approximately 1/2 inch).
7. Crimp the strap closed to secure the feeder buckle in place.

Repeat steps 1 through 7 for the remaining RTD and clamping fixture. When you have completed assembly, proceed to the next section to fasten the RTD to the pipe.

Mounting the RTD to the Pipe

Use the steps below to fasten the RTD to the pipe:

1. Prepare the pipe where you intend to place the RTD. The area should be clean and free of loose material.
2. Apply couplant (GE Infrastructure Sensing part number 401-001) to the copper face of the RTD. Use enough couplant to cover the face of the RTD, but not so much that the couplant oozes out from underneath.
3. Position the RTD on the pipe and wrap the clamping fixture around the pipe.
4. To secure the RTD, you place the feeder buckle into the screw buckle and use a screwdriver to tighten. Turn the screw clockwise until the strap is set securely against the RTD.

Proceed to the following section to make electrical connections.

Making Electrical Connections

The PT878 will not accept a signal directly from the RTD; therefore, you must have some type of 4 to 20-mA transmitter. GE Infrastructure Sensing supplies a dual transmitter (DTR) with a special LEMO connector that attaches to the PT878. The PT878 supplies power to the DTR using an internal 16 V supply. If you decide to supply your own transmitter, you can use the 16 V supply to power your transmitter; however, you will need to order the special LEMO connector cable to connect your transmitter to the PT878.

To make electrical connections, you must connect the RTD sensor to the 4 to 20-mA transmitter, and then connect the DTR to the PT878. Use the following sections to make electrical connections.

Connecting the RTD to the 4 to 20-mA Transmitter

RTDs should have two common leads and one signal lead. If you are using a GE Infrastructure Sensing RTD, the wire colors may vary; however, two of the RTD wires will be the same color. The wires that are the same color are the common leads and the remaining wire is the signal lead.

If you are using your own transmitter, make the necessary connections. If you are using the GE Infrastructure Sensing DTR, connect the RTD wires to the terminal block labeled RTD Inputs. Connect the common and signal wires to the appropriate pins as designated on the terminal block label.

IMPORTANT: *The supply and return RTD cables must be the same length in order to make accurate temperature measurements.*

When you have completed supply and return connections, proceed to the next section.

Connecting the Transmitter to the PT878

If you are using the GE Infrastructure Sensing DTR, simply plug the LEMO connector into the I/O connector as shown in Figure C-1 below.

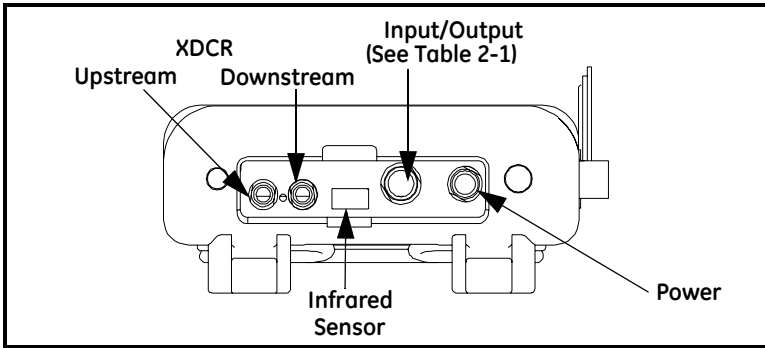

Figure C-1: Connection Locations

If you are using your own transmitter, you must connect the special GE Infrastructure Sensing cable to your transmitter as shown in Table C-1 below.

Table C-1: Cable Connections from GE Infrastructure Sensing Cable to Customer-Supplied Transmitter

Pin Number on GE Infrastructure Sensing Cable	Wire Color on GE Infrastructure Sensing Cable	Description
2	Red	16 V (for unpowered transmitters only)
3	White	Supply Temperature
4	Yellow	Return Temperature
5	Green	Ground (for both supply and return)

Once you complete making the above connection, plug the LEMO connector into the I/O connector as shown in Figure C-1 above. You have completed RTD installation.

Appendix D

Ultrasonic Thickness Gauge Theory of Operation

All ultrasonic thickness gauging involves timing the round trip of a sound pulse in a test material. Because solid metal has an acoustic impedance that differs from that of gasses, liquids, or corrosion products such as scale or rust, the sound pulse will reflect from the far surface of the remaining metal. The test instrument is programmed with the velocity of sound in the test material, and computes the wall thickness from the simple formula

$$\text{Distance} = \text{Velocity} \times \text{Time}$$

Single element transducers use one element as both transmitter and receiver. Dual element transducers incorporate separate transmitting and receiving elements. These elements are mounted on delay lines that are usually cut at an angle to the horizontal plane (the roof angle), so that the transmitting and receiving beam paths cross beneath the surface of the test piece. This crossed-beam design of duals provides a pseudo-focussing effect that optimizes measurement of minimum wall thickness in corrosion applications. Duals will be more sensitive than single element transducers to echoes from the base of pits that represent minimum remaining wall thickness. Also, duals may often be used more effectively on rough outside surfaces. Couplant trapped in pockets on rough sound entry surfaces can produce long, ringing interface echoes that interfere with the near surface resolution of single element transducers. With a dual, the receiver element is unlikely to pick up this false echo. Finally, duals may be designed for high temperature measurements that would damage single element contact transducers.

Factors Affecting Performance and Accuracy

A. Surface Condition - Loose or flaking scale, rust, corrosion or dirt on the outside surface of a test piece will interfere with the coupling of sound energy from the transducer into the test material. Thus, any loose debris of this sort should be cleaned from the specimen with a wire brush or file before measurements are attempted. Generally it is possible to make corrosion measurements through thin layers of rust, as long as the rust is smooth and well bonded to the metal below. Some very rough cast or corroded surfaces may have to be filed or sanded smooth in order to insure proper sound coupling. It may also be necessary to remove paint if it has been applied in thick coats, or if it is flaking off the metal. While it is often possible to make corrosion measurements through thin coats of paint (on the order of a few thousandths of an inch or 0.1 - 0.2 mm), thick paint will attenuate signals or possibly create false echoes, causing inaccurate measurements.

Severe pitting on the outside surface of a pipe or tank can be a problem. On some rough surfaces, the use of a gel or grease rather than a liquid couplant will help transmit sound energy into the test piece. In extreme cases it will be necessary to file or grind the surface sufficiently flat to permit contact with the face of the transducer. In applications where deep pitting occurs on the outside of a pipe or tank it is usually necessary to measure remaining metal thickness from the base of the pits to the inside wall. There are sophisticated ultrasonic techniques utilizing focussed immersion transducers that can measure directly from the base of the pit to the inside wall, but this is generally not practical for field work. The conventional technique is to measure unpitted metal thickness ultrasonically, measure pit depth mechanically, and subtract the pit depth from the measured wall thickness. Alternately, one can file or grind the surface down to the base of the pits and measure normally.

Factors Affecting Performance and Accuracy (cont.)

As with any difficult application, experimentation with actual product samples is the best way to determine the limits of a particular gauge/transducer combination on a given surface.

B. Transducer Positioning/Alignment - For proper sound coupling the transducer must be pressed firmly against the test surface. On small diameter cylindrical surfaces such as pipes, hold the transducer so that the sound barrier material visible on the probe face is aligned perpendicular to the center axis of the pipe. See Figure D-1 below.

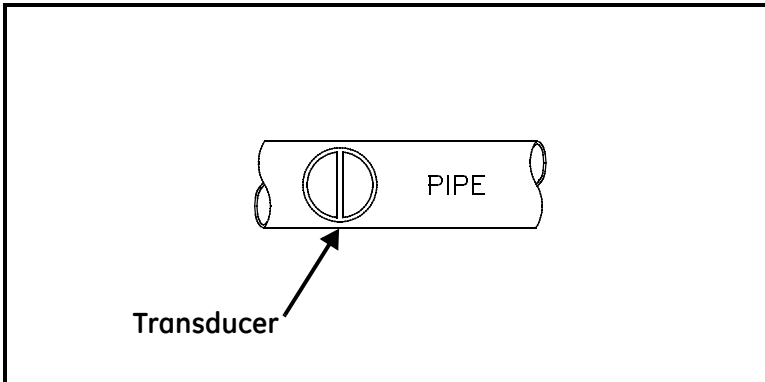

Figure D-1: Proper Alignment of Transducers for Cylindrical Surfaces

While firm hand pressure on the transducer is necessary for good readings, the probe should never be scraped along or twisted against a rough metal surface. This will scratch the face of the transducer and eventually degrade performance. The safest technique for moving a transducer along a rough surface is to pick it up and reposition it for each measurement, not to slide it along.

Factors Affecting Performance and Accuracy (cont.)

Remember that an ultrasonic test measures thickness at only one point within the beam of the transducer, and that in corrosion situations wall thicknesses often vary considerably. Test procedures usually call for making a number of measurements within a defined area and establishing a minimum and/or average thickness. Ideally, data should be taken at increments no greater than half the diameter of the transducer, to insure that no pits or other local variations in wall thickness are missed. It is up to the user to define a pattern of data collection appropriate to the needs of a given application.

It is possible that on some severely corroded or pitted materials there will be spots where readings cannot be obtained. This can happen when the inside surface of the material is so irregular that the sound energy is scattered rather than being reflected back to the transducer. The lack of a reading may also indicate a thickness outside the range of the transducer and instrument being used. Generally, an inability to obtain a valid thickness reading at a particular point on a test specimen could be a sign of a seriously degraded wall which may warrant investigation by other means.

C. Calibration - The accuracy of measurements are only as good as the accuracy and care with which the gauge has been calibrated. It is essential that the thickness gauge be calibrated (as shown on page 8-5) whenever the transducer is changed or you have a reason to doubt the accuracy of the readings. Periodic checks with samples of known thicknesses are recommended to verify that the gauge is operating properly.

Factors Affecting Performance and Accuracy (cont.)

D. Taper or Eccentricity - If the contact surface and the back surface are tapered or eccentric with respect to each other, the return echo again becomes distorted and the accuracy of measurement is diminished.

E. Acoustic Properties of the Material - There are several conditions found in engineering materials that can severely limit the accuracy and thickness range that can be measured.

1. Sound Scattering

In some materials, notably certain types of cast stainless steel, cast irons, and composites, the sound energy is scattered from individual crystallites in the casting or from dissimilar materials within the composite. This effect reduces the ability to discriminate a valid return echo from the back side of the material and limits the ability to gauge the material ultrasonically.

2. Velocity Variations

A number of materials exhibit significant variations in sound velocity from point-to-point within the material. Certain types of cast stainless steels and brass exhibit this effect due to a relatively large grain size and the anisotropy of sound velocity with respect to grain orientation. Other materials show a rapid change in sound velocity with temperature. This is characteristic of plastic materials where temperature must be controlled in order to obtain maximum precision in the measurement.

3. Sound Attenuation or Absorption

In many organic materials, such as low density plastics and rubber, sound is attenuated very rapidly at the frequencies used in normal ultrasonic thickness gaging. Therefore, the maximum thickness that can be measured in these materials is often limited by sound attenuation.

Appendix E

Material Safety Data Sheet for Couplant

Material Safety Data Sheet

(To comply with 29 CFR 1910.1200)

Effective Date 4/1/98

Note: *N/A = not applicable or not available*

Section 1— Product Identification

Product Name: **SOUNDSAFE®**

Generic Name: Ultrasonic Couplant

Manufacturer: Sonotech, Inc.

774 Marine Dr., Bellingham, WA 98225

360-671-9121

FAX: 360-671-9024

E-mail: sonotech@nas.com

<http://www.sonotech-inc.com>

NFPA Hazardous Materials Identification System (est)

Health.....0

Flammability.....0

Reactivity.....0

Section 2 – Hazardous Ingredients

This material does not contain any ingredients having known health hazards in concentrations greater than 1%.

This material does not contain any known or suspected carcinogens.

Section 3 — Physical Data (nominal)

Boiling Point: >220°F

Freezing Point: <20°F

Vapor Pressure: N/A

Evaporation Rate: N/A

Solubility in Water: complete

Appearance and Odor: water white, opaque gel; bland odor

pH: 7.35 - 7.9

Acoustic Imp.: 1.726×10^6

Vapor Density: N/A

Specific Gravity: 1.05

Section 4 — Fire and Explosion Hazard Data

Flash Point: none

Upper Exposure Limit: none

Lower Exposure Limit: none

Special Fire Fighting Procedures: N/A

Extinguishing media: N/A

Unusual Fire and Explosion Hazards: none

Section 5 — Reactivity Data

Stability: stable

Conditions to Avoid: none

Incompatibility (*Materials to Avoid*): none known

Hazardous Polymerization: will not occur

Hazardous decomposition or Byproducts: none known

Section 6 — Health Hazard and First Aid Data

Routes of Entry:¹

Skin: not likely

Eyes: not normally

Ingestion: not normally

Inhalation: no

¹**SOUNDSAFE**® contains only food grade and cosmetic grade ingredients.

Effects of Overexposure:

Acute: May cause temporary eye irritation.

Chronic: None expected.

First Aid Procedures:

Skin: Remove with water if desired.

Eyes: Flush with water for 15 minutes.

Ingestion: For large quantities, induce vomiting and call a physician.

Inhalation: N/A

Section 7 —Storage and Handling Information

Precaution to be taken in handling and storage:

Store between 20°F and 120°F. Spills are slippery and should be cleaned up immediately.

Steps to be taken in case material is released or spilled: Pick up excess for disposal. Clean with water.

Waste disposal method: Dispose of in accordance with federal, state, and local regulations.

Section 8 – Control Measures

Respiratory Protection: not required

Ventilation: not required

Protective Gloves: on individuals demonstrating sensitivity to
SOUNDSAFE®

Eye Protection: as required by working conditions

Other Protective Equipment: not required

Appendix F

Establishing IR Communications with the PT878

As discussed in Chapter 2, the PT878 includes an infrared transceiver for communication with IR products that comply with the IrDA protocol. However, you must also be sure that the operating system of your personal computer offers IrDA compatibility and either a built-in IR port (available on most laptops) or an IR dongle (IR to RS232 adapter for PCs without a built-in IR port). If your PC does not have an IR dongle, GE Infrastructure Sensing recommends the ActiSys ACT-IR220L+ infrared to RS-232 adapter, which has been tested for compatibility with the PT878. Be sure to position the interface in a way that permits transmission between the interface and the infrared sensor on the PT878, shown in Figure 2-2 on page 2-2.

Table F-1 below lists IrDA compatibility for various past and current Microsoft Windows operating systems. IrCOMM is an infrared standard supported by Microsoft, while OBEX is a newer infrared standard which allows more straightforward use and faster file transfers, while tolerating IR interruptions better.

Table F-1: IrDA Compatibility of Windows Operating Systems

Operating System	IrCOMM	OBEX
Windows XP	No	Yes
Windows 2000	No	Yes
Windows NT 4.0	QuickBeam*	QuickBeam*
Windows Me*	Yes	Yes
Windows 98 SE*	Yes	Yes
Windows 98*	Yes	Yes
Windows 95*	Yes	Yes
Windows 3.1	No	No
DOS 6.22	No	No

March 2005

*May require QuickBeam installation under some circumstances when Windows built-in support fails. QuickBeam is a recommended infrared file software transfer utility from Extended Systems, Inc. Since Windows NT4.0 does not provide built-in support for IR file transfer, QuickBeam is necessary with this operating system.

Windows 2000/XP

Both Windows 2000 and XP include infrared drivers in their operating systems. From the *Control Panel*, click on *Add New Hardware* and select the appropriate IR port, whether built-in or using an external dongle.

Windows NT4.0

For IR use, Windows NT4.0 requires installation of QuickBeam software from Extended Systems (www.extendedsystems.com). Desktop PCs and laptops without built-in IR ports also require adding an IR dongle. While laptops with a built-in IR port normally do not require a dongle, its addition might be necessary in some cases.

Windows Me/98SE/98/95

The Windows 98SE and Me operating systems include IR drivers. However, in most cases, the IR port has not been installed or configured. From the *Control Panel*, click on *Add New Hardware* and select *Choose Device From List*. Select *Infrared* from the list and then select the appropriate infrared port, whether built-in or external.

Note: *In some instances, the infrared port must be enabled in the BIOS of your PC. Consult your computer documentation, manufacturer or MIS department. Assistance is also available from the Microsoft Support Knowledge Base at <http://support.microsoft.com>.*

Appendix G

Glossary

AGC — Automatic gain control, which sets the receive amplifier based on measured signal strength. This electronic circuit automatically adjusts the gain of the receive amplifier to maintain the correct receive signal amplitude.

Calibration Factor — Correction factor used as a reference for the flowmeter electronics to ensure accurate readings, and available either as a single number or as a table.

Delta-T Offset — A programmed value of which half is added to the upstream transit time and half is subtracted from the downstream transit time. It can be used to offset the flow velocity reading, and is normally set to zero.

Detection Threshold — Percent of peak the PT878 thickness gauge uses to make measurements

Energy Option — Option that enables flow measurement in a heating or cooling system. The option calculates the energy of a system based on the temperature at a supply point, the temperature at a return point, and the flow of fluid through the system.

Errors Allowed — Parameter that specifies the number of errors the meter can record before displaying an error message. The number of errors is N out of 16 where N equals the number of errors allowed.

Flowcell — The part of the flowmeter system, consisting of the flowcell pipe and the transducers, that uses ultrasonic pulses to interrogate the flow.

Flowcell Pipe — A section of piping that acts as part of the flowcell; it is either a section of existing piping with the transducers or inserted as a substitute pipe section (spoolpiece).

Form — Software window that opens when a user enters a given menu.

Impulse Response — Option in the Service Menu that enables you to force the meter to transmit in one direction only, without changing the amplifier gain setting.

Locale — Format for displaying the time and date.

Peak Detection — A method for identifying the ultrasonic signature in the received signal. In the “Peak” method, the peak is identified by testing a derivative of the signal. In the “Threshold” method, the peak is identified as the point where the signal crosses a threshold that is a percentage of the maximum signal detected.

Receive Window — A window of time during which the PT878 tries to detect the ultrasonic signal. It is determined by using the fluid sound speed and the signal path length to estimate when the signal will arrive at the receiving transducer.

Reynolds Correction— Correction factor based on the Kinematic Viscosity and flow rate of the fluid.

Signal Inversion — Option that enables a thickness gauge user to invert the transducer signal.

Signal Path — Path the ultrasonic signal travels from one transducer to the other.

Simulate — Option in the Service Menu that allows users to simulate measurements based on a waveform stored in the PT878.

Site — A location on a pipe where measurements are made. The site includes the transducers, pipe, fluid type, pipe material and other parameters.

Site File — Instrument program that combines all the necessary parameters (transducer, pipe, fluid, etc.) for a particular measurement location.

Snapshot — Option in the Meter Menu to take screen captures in bitmap format of a given screen display.

Sound Speed — Speed at which a sound wave travels through a given material.

Thickness Gauge — Option that allows the PT878, with an optional thickness gauge transducer, to determine the thickness of most standard metal and plastic pipe materials over a range from 0.05 to 3 in. (1.3 to 76.2 mm).

Tw (time in wedge) — Time the transducer signal spends travelling through the transducer and cable. This time has to be subtracted from the transit time to determine how much time the signal spent in the fluid.

Tracking Windows — A feature which allows the receive window to move automatically if the ultrasonic signal is lost. The PT878 will set up the window in various positions based on a minimum and maximum sound speed range. In seek mode, the meter will test every position until it detects a receive signal that passes the error tests. The first window (highest sound speed setting) that passes the tests is the detected window. The meter will then track the receive signal.

Transducer Delay — Time the ultrasonic signal takes to travel from the meter to the pipe material surface. It is a similar measurement to Tw, except that the delay is subtracted from the transit time to find out how much time is spent in the wall.

Transducers — Devices that convert electrical energy into ultrasonic pulses when in a transmit cycle, and convert the ultrasonic pulses back to electrical energy when in a receive cycle. They can be fixed to the outside of the flowcell pipe (clamp-on) or inserted into the pipe to directly measure the fluid (wetted).

Transmitter Sample Size — Number of pulses the transmitter emits in one direction (upstream or downstream) before transmitting in the other direction. It is set to 8 by default.

Transit-Time — Flow measurement technique based on the principle that when ultrasonic pulses are transmitted through a moving liquid, the pulses that travel in the same direction as the fluid flow (downstream) travel slightly faster than the pulses that travel against the flow (upstream). When the liquid in the pipe is not flowing, the transit-time downstream equals the transit-time upstream. When the liquid is flowing, the transit-time downstream is less than the transit-time upstream. The difference between the downstream and upstream transit-times is proportional to the velocity of the flowing liquid, and its sign indicates the direction of flow.

Traverses — Number of times the ultrasonic signal crosses the pipe.

User Functions — User-defined mathematical equations for use with any measurement.

User Tables — User-defined tables of data for use with user functions.

Velocity Averaging — Parameter that averages a desired number of velocity measurements to smooth out or dampen noise in the system.

Watchdog Test — Option in the Service Menu that tests the watchdog timer circuit. If a software error causes the meter to stop responding, this circuit automatically resets the meter

Wave Snapshot — Option in the Service Menu that enables users to capture waveforms for downloading to a PC for analysis, or for simulating a flow measurement.

Wedge Angle — Angle of the transducer's ultrasonic transmission in the transducer wedge.

Zero Cutoff — Parameter that causes velocity measurements less than the absolute value of the cutoff (either positive or negative values) to be reported as zero.

Index

A

About Option	5-22
Acceleration Limit	8-32
ACTiSYS ACT-IR interface	2-4
ActiSys ACT-IR220L+ infrared adapter	F-1
Amplitude Discriminator Limits	8-32
Analog Input Calibration	8-21
Analog Input Option	
Menu Map	A-12
Analog Inputs	
Connections	2-3
in Energy Option	3-29, 3-30
Analog Inputs, Entering	3-27
Analog Output Calibration	8-21
Analog Output Option	3-31
Menu Map	A-13
Analog Output, Entering	3-31
Analog Outputs	
Connections	2-3
ANSI Schedule, Applying	3-10
Arrow Keys	2-12
Axial Length, Entering	3-18

B

Backlight Option	6-13
Backlight, Timeout for	6-13
Bar Graph Display	5-4
Batteries	
Charge	2-5
Charging	2-5
Replacing	2-6
Battery Charger	6-4, 6-5
Battery Option	6-4
Battery Test Option	8-40
Battery, Testing	8-40

Index (cont.)

C

Calibration	
Analog Input	8-21
Analog Output	8-21
Calibration Factor, Entering a	3-44
Capturing Signals	8-39
Checks	
Power Up	2-7
Clamp-On Transducers	
Path Parameters for	3-17
Clearing Softkey	5-13
Communications Option	6-16
Menu Map	A-17
Configuring the display	5-1
Connections	2-2
Analog Inputs	2-3
Analog Outputs	2-3
Power	2-3
Transducers	2-3
Contrast Option	6-11
Contrast, Adjusting	6-11
Correction Factors Option	3-42
Menu Map	A-16
Correction Factors, Entering	3-42
Customizing Softkeys	5-11

Index (cont.)

D

Data Acquisition	1-4
Data Sources, Changing	5-7, 5-8
Date and Time Options	6-8
Date, Entering	6-6
Date/Time Format, Changing	6-8
Defaults, Resetting to	8-41
Delta-T Offset	8-26, G-1
Description	
Electronics	1-4
Error Messages	9-2
Flowcell	1-3
Keypad	2-12
Keys	2-12
Screen	2-10
System	1-3
Detection Threshold	8-19
Diagnostic Parameters, Displaying	8-20
Diagnostics	9-1, 9-5
Error Messages	9-2
Diagnostics Option	8-20
Digital Output Option	3-34
Menu Map	A-14
Display	
Screen	2-10
Display Options	6-8
Display Screen, Configuring	5-9
Displaying Data as Graph	5-4
Displaying Details	7-19
Drive Manager	5-14

Index (cont.)

E

Electrical	
Connections.	2-2
Electrical Connections.	2-2
Electronics	
Connections.	2-2
Description	1-4
Error Messages	9-2
Specifications	10-4
Theory of Operation	1-5
Energy Option	
Entering Inputs	3-21, 3-24, 3-25, 3-26
Entering Parameters	3-19
Menu Map.	A-11
English Units.	6-3
ENT Key	2-12
Error Limits Option.	8-31
Error Messages	9-2
Battery	2-5
Errors Allowed	8-27, G-1
EXIT Key	2-12

Index (cont.)

F

Factory Defaults Option	8-41
Feature Keys	2-12
File	
Transferring to PC.....	5-16
File Manager	
Sort Menu	5-20
File Menu	
in Log Manager.....	7-4
File, Transferring from PC	4-15, 5-17, 5-18
Flash Update Option	8-43, 8-46
Flowcell.....	1-3
Description	1-3
Flowcell Piping	1-3
Fluid Option	3-13
Menu Map.....	A-9
Fluid Problems	
Flowcell Problems	9-8
Fluid Speeds, Entering	3-13
Fluid Types, Entering	3-13
Format Option.....	5-2
Forward Total, Resetting	6-19
French Language Display	6-14
Frequency	3-36

G

Gate Input	3-37
Graph Display	5-4

H

Help.....	2-14
Hyperterminal	
for Software Update	8-45

Index (cont.)

I

Impulse Response Option	8-38
Infrared Wireless Interface	2-4
Initial Setup	2-1
Input/Output	1-4
Input/Output Connections	2-3, 2-4
Inputs	
Analog Inputs	2-3
Analog, Entering	3-27
in Energy Option	3-21, 3-24, 3-25, 3-26
IR Communications	
Changing Parameters	6-16
Establishing with PT878	F-1
File Transfer	5-16
Using Drive Manager	5-14

K

Keypad	
Description	2-12
Key Description	2-12
Keys	
Description	2-12
Kinematic Viscosity, Entering	3-43

Index (cont.)

L

Language Option	6-14
Language, Changing	6-14
Limits Option	5-5
Line Graph Display	5-4
Lining Option	
Menu Map	A-8
Lining Parameters, Entering	3-11
Listing Files	
By Date	4-18
by Date	5-21
By Name	4-18
by Name	5-20
Listing Logs	
by Date	7-24
by Name	7-24
Locale Option	6-8
Log	7-19
Copying a	7-10
Deleting a	7-11
Ending a	7-16
in Graph Form.	7-20, 7-21, 7-22
in Spreadsheet Format.	7-23
Printing	7-13
Renaming a	7-11
Restarting	7-16
Stopping a	7-16
Transferring to PC.	7-14
Log Manager	7-3
Sort Menu	7-24
Log Menu	
in Log Manager.	7-15
Log, Creating a	7-5
Logging Menu	
Menu Map	A-5
Logging Menu, Entering	7-2
Logs	
Deleting All.	7-12
Ending All.	7-17
Stopping All	7-17
Low Signal Threshold	8-18

Index (cont.)

M

Main Menu	
Menu Map.....	A-1
Material	
in Thickness Gauge Setup Option.....	8-6
Measurement Option.....	5-7, 5-8
Measurement Parameters, Changing.....	5-7, 5-8
Measurement Units, Selecting.....	6-3
Meter Menu	
Menu Map.....	A-4
Meter Menu, Entering.....	6-2
Meter Settings Window.....	6-3
Metric Units.....	6-3
Microcomputer.....	1-4
Model number.....	5-22

N

Node ID for Communications.....	6-16
Noise Threshold.....	8-18
Numeric Keys.....	2-12

O

On-Line Help.....	2-14
Getting.....	2-14
Output	
Analog, Entering.....	3-31
Digital, Entering.....	3-34
Outputs	
Analog Outputs.....	2-3

Index (cont.)

P

Parameters, Displayed	5-10
Path	
for Clamp-on	3-17
Path for Wetted Transducers	3-18
Path Length, Entering	3-18
Path Option	3-16
Menu Map	A-10
PC File Transfer	4-15, 5-17, 5-18
Peak Detection	8-28
Pipe Diameter, Entering	3-9
Pipe Lining, Entering	3-11
Pipe Material	3-8
Pipe Option	
Menu Map	A-3
Pipe Problems	9-9
Power	
Connections	2-3
Turn On and Off	2-7
Power Connections	2-3
Powering On/Off	2-7
Printing a Log	7-13
Problems	
Flowcell	9-8
Fluid	9-8
Pipe	9-9
Transducers	9-11
Program Menu	3-1
Menu Map	A-3
PT878	
Keypad	2-12
Powering On/Off	2-7
Screen	2-10
PT878 Software, Updating	8-42
PT878, Features of	1-1
Pulse Totalizer	3-35

R

Receiver	1-4
Refreshing	
a Site	4-9
Reports Option	8-3, 8-4
Reports, Printing	8-3, 8-4
Reverse Total, Resetting	6-19
Reynolds Correction, Entering	3-42

Index (cont.)

S

Sampling Waves	8-39
Schedule for Pipe Dimensions	3-9
Screen	
Description	2-10
On-Line Help	2-14
Service Menu	
Menu Map	A-6
Service Menu, Entering	8-2
Setting up PC for Flash Update	8-45
Signal Inversion	8-18, G-2
Signal Parameters, Setting up	8-25
Signal Path, Entering	3-16
Signal Setup Option	8-25
Signal, Applying a Stored	8-39
Signals, Capturing	8-39
Simulate Option	8-39
Site	
Creating a Message	4-11
Deleting a	4-10, 5-19, 5-20
Printing a	4-13
Refreshing a	4-9
Renaming a	4-9
Saving a	4-7
Saving with Different Name	4-8
Transferring to PC	4-13, 4-14
Site Manager	4-2
Sort Menu	4-18
Site Menu	4-1
Site, Creating a New	4-4
Site, Open a	4-6
Softkey, Clearing a	5-13
Softkeys, Customizing	5-11
Software version	5-22
Sort Menu	
in File Manager	5-20
in Log Manager	7-24
in Site Manager	4-18
Sound Speed Limits	8-32
Sound Speed, Calculating	8-14, 8-15
Span (Full Scale) Value	
for Analog Output	3-33
Special Transducers	
Entering Data	3-5
Specifications	
Overall	10-2

Index (cont.)

S (cont.)

Pipe Size and Material	10-8
Thickness Gauge	10-9
Transducer	10-7
Stopwatch Totalizer	3-37
System	
Description	1-3

T

Task Keys	2-12
Temperature	
Transmitter Installation	C-1
Test Keys	8-36
Test Points	3-36
Test Screen	8-35
Testing Timer Circuit	8-37
Theory of Operation	1-5
Thickness	
Calibrating	8-11
Displaying in Graphical Format	8-9, 8-10
Displaying in Numeric Format	8-8
Thickness Gauge	
Calibrating	8-11
Entering Programming Data	8-17
Low Signal Threshold	8-18
Setup	8-5
Sound Speed	8-14, 8-15
Specifications	10-9
Theory of Operation	D-1
Thickness Gauge Setup	8-18
Detection Threshold	8-19
Signal Inversion	8-18, G-2
Transducer Delay	8-18
Time Delay, Entering	3-5
Time, Entering	6-6
Timing Circuit	1-4
Totals, Resetting	6-19
Tracking Windows	3-13
Transducer	10-7
Transducer Connections	2-3
Transducer Delay	8-18
Transducer Number, Entering	3-4
Transducer Option	3-3
Menu Map	A-7
Transducer Signal Limits	8-31

Index (cont.)

T (cont.)

Transducer Spacing, Entering	3-17
TRANSDUCERS	1-3, G-3
Transducers	1-3, G-3
Axial Dimension	B-1
Bias 90° Installation	B-1
Connections	2-3
Entering Data for	3-3
Installation Angle	B-1
Path Length	B-1
Problems	9-11
Special	3-5
Wetted or clamp-on	3-3
Transfer	
Log	7-14
Transit-Time, Theory of	1-5, G-4
Transmit Signal Generator	1-4
Transmitter	1-4
Transmitter Sample Size	8-26, G-3
Traverses, Entering Number	3-17
Troubleshooting	9-1
Error Messages	9-2
Turning On/Off	2-7
Tw (time delay)	3-5

U

Units Option	6-3
User Functions Option	3-38
Menu Map	A-15
User Functions, Entering	3-38
User Table Option	6-20
User Tables, Creating	6-20

V

Velocity Averaging	8-27
Velocity Limits	8-32
View All Sites Option	7-17
View Menu	
in Log Manager	7-18
View Option	5-4

Index (cont.)

W

Watchdog Test	8-37
Wave Sampling	8-39
Wave Snapshot Option	8-39
Wedge Angle, Entering	3-5
Wedge Sound Speed, Entering	3-6
Wedge Temperature, Entering	3-6
Wetted Transducers	
Path Parameters for	3-18
Windows Operating Systems	
Compatibility with IR	F-1

Z

Zero (Base) Value	
for Analog Output	3-33
Zero Cutoff	8-26

We, **Panametrics Limited**
Shannon Industrial Estate
Shannon, County Clare
Ireland

declare under our sole responsibility that the

TransPort™ PT878 Portable Ultrasonic Flowmeter
TransPort™ PT878GC Clamp-On Portable Ultrasonic Flowmeter
TransPort™ 2PT868 2-Channel Portable Ultrasonic Flowmeter
TransPort™ PT868 Portable Ultrasonic Flowmeter
TransPort™ PT868-L Portable Ultrasonic Flowmeter
TransPort™ PT868-R Portable Ultrasonic Flowmeter with TransFlection™ Mode

to which this declaration relates, are in conformity with the following standards:

- EN 61326:1998, Class A, Annex C, Continuous Unmonitored Operation

following the provisions of the 89/336/EEC EMC Directive.

The units listed above and any transducers supplied with them (spoolpieces are addressed under a separate declaration of conformity) do not bear CE marking for the Pressure Equipment Directive, as they are supplied in accordance with Article 3, Section 3 (sound engineering practices and codes of good workmanship) of the Pressure Equipment Directive 97/23/EC for DN<25.

Shannon - June 1, 2002

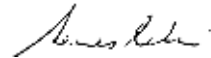

Mr. James Gibson
GENERAL MANAGER



CERT-DOC-H5



August 2004)

Nous,

Panametrics Limited
Shannon Industrial Estate
Shannon, County Clare
Ireland

déclarons sous notre propre responsabilité que les

TransPort™ PT878 Portable Ultrasonic Flowmeter
TransPort™ PT878GC Clamp-On Portable Ultrasonic Flowmeter
TransPort™ 2PT868 2-Channel Portable Ultrasonic Flowmeter
TransPort™ PT868 Portable Ultrasonic Flowmeter
TransPort™ PT868-L Portable Ultrasonic Flowmeter
TransPort™ PT868-R Portable Ultrasonic Flowmeter with TransFlection™ Mode

relatif à cette déclaration, sont en conformité avec les documents suivants:

- EN 61326:1998, Class A, Annex C, Continuous Unmonitored Operation

suivant les règles de la Directive de Compatibilité Electromagnétique 89/336/EEC.

Les matériels listés ci-dessus ainsi que les transducteurs pouvant être livrés avec (les manchettes faisant l'objet d'une déclaration de conformité séparée) ne portent pas le marquage CE de la directive des équipements sous pression, car ils sont fournis en accord avec la directive 97/23/EC des équipements sous pression pour les DN<25, Article 3, section 3 qui concerne les pratiques et les codes de bonne fabrication pour l'ingénierie du son.

Shannon - June 1, 2002

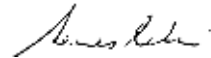

Mr. James Gibson
DIRECTEUR GÉNÉRAL



CERT-DOC-H5



August 2004)

Wir,

Panametrics Limited
Shannon Industrial Estate
Shannon, County Clare
Ireland

erklären, in alleiniger Verantwortung, daß die Produkte

TransPort™ PT878 Portable Ultrasonic Flowmeter
TransPort™ PT878GC Clamp-On Portable Ultrasonic Flowmeter
TransPort™ 2PT868 2-Channel Portable Ultrasonic Flowmeter
TransPort™ PT868 Portable Ultrasonic Flowmeter
TransPort™ PT868-L Portable Ultrasonic Flowmeter
TransPort™ PT868-R Portable Ultrasonic Flowmeter with TransFlection™ Mode

folgende Normen erfüllen:

- EN 61326:1998, Class A, Annex C, Continuous Unmonitored Operation

gemäß den Europäischen Richtlinien, Niederspannungsrichtlinie EMV-Richtlinie
Nr.: 89/336/EG

Die oben aufgeführten Geräte und zugehörige, mitgelieferte Schallwandler (Messrohre werden in einer separaten Konformitätserklärung behandelt) tragen keine CE-Kennzeichnung gemäß der Druckgeräte-Richtlinie, da sie in Übereinstimmung mit Artikel 3, Absatz 3 (gute Ingenieurpraxis) der Druckgeräte-Richtlinie 97/23/EG für DN<25 geliefert werden.

Shannon - June 1, 2002

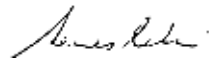

Mr. James Gibson
GENERALDIREKTOR



CERT-DOC-H5



August 2004)



USA

1100 Technology Park Drive
Billerica, MA 01821-4111
Web: www.gesensing.com

Ireland

Shannon Industrial Estate
Shannon, County Clare
Ireland

